

RADIO'S LIVEST MAGAZINE

Special
RADIO
VOCATION
Number

Radio-Craft

November
25 Cents
in 1935
and 1936

Aviation Radio

HUGO GERNSBACK Editor

Broadcasting



Television

Electronics



Servicing

Public Address

Radio and Public Address at the Olympics — The New "Mike-Speaker"
The New Philco Television System — Putting New Tricks into Old Sets

OVER 175 ILLUSTRATIONS

*Doubles
World-Wide
Radio Enjoyment
and Slashes
Radio Current Bills
in Half!*

Only **MIDWEST GIVES YOU**
PUSH BUTTON TUNING

plus Exclusive New
ELECTRIK-SAVER
for 1937



ELECTRIK-SAVER cuts radio wattage consumption 50%...enables 16-tube Midwests to consume no more current than ordinary 7-tube radios and to operate on voltages as low as 80 volts.



PUSH BUTTON TUNING
Finger tip tuning is made possible with the Midwest Automatic Push Button Tuning System. Doubles radio enjoyment.

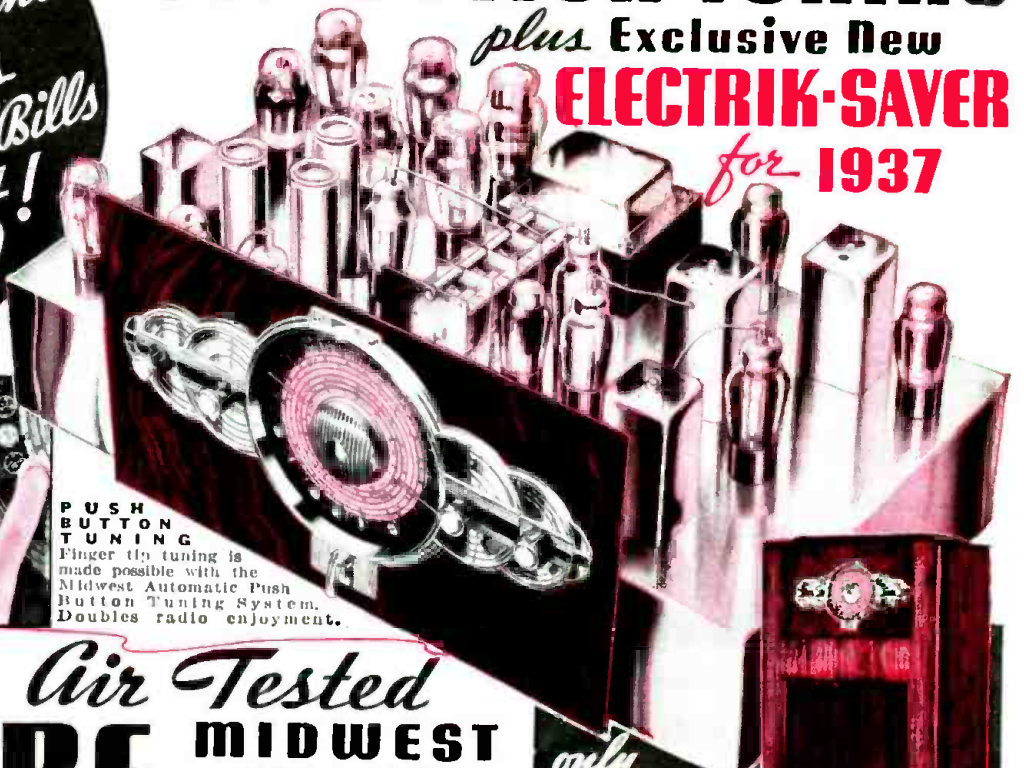

NEW 1937 Air Tested
16-TUBE MIDWEST FIVE-BAND RADIO

SAVE UP TO 50% DIRECT FROM FACTORY

NO middlemen's profits to pay! See for yourself that Midwest offers you greater radio values—enables you to buy the more economical factory-to-you way that scores of thousands of radio purchasers have preferred since 1920. Never before so much radio for so little money! Why pay more? The broad Midwest Foreign Reception and Money-Back Guarantees insure your satisfaction. You get 30 days FREE trial in your own home!

Once again, Midwest demonstrates its leadership by offering the world's most powerful and most beautiful ALL-WAVE 16-tube, 5-Band Radio. A startling achievement, it makes the whole world your playground. Powerful Triple-Twin tubes (two tubes in one!) give 18-tube results. This advanced radio is a master achievement, a highly perfected, precisely built, radio-musical instrument that will thrill you with its marvelous super performance...glorious crystal-clear "concert" realism...and magnificent foreign reception. The Dual Audio Program Expander gives a living, vital realistic quality to voice and musical reproduction.

74 ADVANCED 1937 FEATURES

This Super DeLuxe Midwest is so powerful, so amazingly selective, so delicately sensitive that it brings in distant foreign stations with full loud speaker volume on channels adjacent to powerful locals. Scores of marvelous Midwest features, many of them exclusive, make it easy to parade the nations of the world before you. You can switch instantly from American programs...to Canadian, police, amateur, commercial, airplane and ship broadcasts...to the finest and most fascinating foreign programs. With a Midwest, the finest entertainment the world has to offer is at your command. It is preferred by famous orchestra leaders, musicians, movie stars and discriminating radio purchasers everywhere. You can order your Midwest "Air-Tested" radio from the new 40-page catalog with as much certainty of satisfaction as if you were to come yourself to our great factory. (It pictures the beautiful 1937 radios...in their actual colors!) You pay as little as \$5.00 down! Three iron-clad guarantees protect you: (1) A Foreign Reception Guarantee — (2) Absolute Guarantee of Satisfaction — (3) One-Year Warranty.



MIDWEST USES LESS CURRENT THAN AN ORDINARY LIGHT BULB

Fill in coupon NOW, and mail TODAY!



MY MIDWEST NOT ONLY MEETS BUT SURPASSES MY MOST CRITICAL STANDARDS.

Bina Crosby



NO SET THAT I HAVE EVER OWNED HAS BROUGHT IN FOREIGN RECEPTION SO CONSISTENTLY AND SATISFACTORILY.

Gloria Stuart

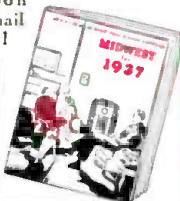

only
\$49.95



WITH GIANT THEATRE-SONIC SPEAKER (LESS TUBES)

TERMS AS LOW AS \$5.00 DOWN

Only **MIDWEST Gives You**
16 TUBES • 5 WAVE BANDS

9 to 2200 METERS • ELECTRIK SAVER

- PUSH BUTTON TUNING •
- AUTOMATIC AERIAL ADAPTION •

DOUBLE PUSH-PULL AUDIO

30 DAYS FREE TRIAL!

MAIL COUPON TODAY for
Free 30-DAY TRIAL OFFER
and 40-PAGE FOUR-COLOR Free CATALOG

MIDWEST RADIO CORPORATION
Dept. E-12, Cincinnati, Ohio

Without obligation on my part, send me your new FREE catalog and complete details of your liberal 30-day FREE trial offer. This is NOT an order.

Special offer and prices prevail only when dealing direct with factory by mail.

Name _____
Address _____
Town _____ State _____

MIDWEST RADIO CORP.

DEPT. **E-12**
Established 1920



CINCINNATI, OHIO, U.S.A.
Cable Address **MIRACO...All Codes**

OPPORTUNITIES *are many* for the Radio Trained Man

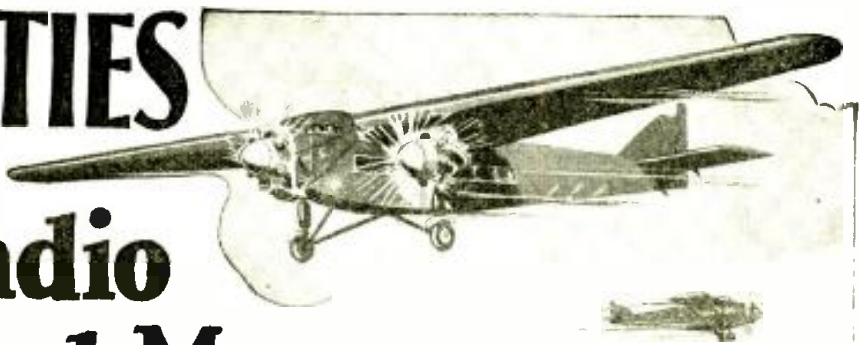

Don't be an untrained man. Let me show you how to get your start in Radio—a fast growing, live money-making industry.

Prepare for jobs as Assembler, Inspector and Tester—Radio Sales or Service and Installation Work—Broadcasting Station Operator—Wireless Operator on a Ship or Airplane, Talking Picture or Sound Work—**HUNDREDS OF OPPORTUNITIES** for a real future in Radio!

12 Weeks of Shop Training Pay Your Tuition After Graduation

We don't teach by book study. We train you on a great outlay of Radio, Television and Sound equipment—on scores of modern Radio Receivers, actual Broadcasting equipment, Television apparatus, Talking Picture and Sound Reproduction equipment, Code and Telegraph equipment, etc. You don't need advanced education or previous experience. We give you—**RIGHT HERE IN THE COYNE SHOPS**—the actual practice and experience you'll need for your start in this great field. And because we cut out all useless theory and only give that which is necessary you get a practical training in 12 weeks. Mail coupon for all facts about my school and training methods.



TELEVISION *and* TALKING PICTURES

Television is sure to come as a commercial industry. Whether this year or later, it will offer opportunities to the man who is trained in Radio. Here at Coyne you learn Television principles, and work on actual Television equipment. Talking Picture and Public Address Systems offer opportunities to the Trained Radio Man. Here is a great new Radio field which is rapidly expanding. Prepare NOW for these wonderful opportunities! Learn Radio Sound Work at COYNE on actual Talking Picture and Sound Reproduction equipment.

ARRANGE TO FINANCE YOUR TUITION

I am making an offer that is the most unusual ever made by a school. I'll take you here in my shops and give you this training and arrange a plan for you to pay your tuition in small monthly payments extending over an 18-month period, the first payment to be made 5 months after you start school. I know a lot of honest fellows haven't much money these days, but still want to prepare themselves for their start towards a real job, steady work and better pay.

Mail the coupon for all details of this "Pay Tuition after Graduation Plan."

ELECTRIC REFRIGERATION AIR CONDITIONING

To make your training more valuable, I include—at no extra cost additional instruction in Electric Refrigeration, Air Conditioning and Diesel Engines, taught you by personal instruction and actual work on real equipment.

PRACTICAL WORK At COYNE in Chicago

ACTUAL, PRACTICAL WORK. You build and service radio sets. You get training on real Broadcasting equipment. You construct Television Receiving Sets and actually transmit your own Television images over our Television equipment. You work on real Talking Picture and Sound equipment. You learn Wireless Operating on Actual Code Practice apparatus. We don't waste time on useless theory. We give you the practical training you'll need for

your start in Radio—in 12 short, pleasant weeks. If you desire code, this requires additional time for which there is no extra charge.

MANY EARN WHILE LEARNING

You get Free Employment Service for Life. And don't let lack of money stop you—my plan makes it possible to get Coyne training with very little money. Many of our students earn part of their living expenses while going to school and if you should need this help just write to me. Coyne is 37 years old. Coyne Training is tested. You can find out everything absolutely free. Just mail coupon for my big free book!

H. C. Lewis, Pres. RADIO DIVISION Founded 1899
Coyne Electrical School
500 S. Paulina St., Dept. 86-8H, Chicago, Ill.

Mail Coupon Today for All the Facts

H. C. LEWIS, President

Radio Division, Coyne Electrical School
500 S. Paulina St., Dept. 86-8H, Chicago, Ill.

Dear Mr. Lewis:—Send me your Big Free Radio Book, and all details of your Special Offer, including additional instruction in Electric Refrigeration, Air Conditioning and Diesel Training and your "Pay After Graduation" offer.

Name

Address

City State



HUGO GERNSBACK, Editor-in-Chief
 C. W. PALMER Associate Editor
 H. G. McENTEE Associate Editor
 R. D. WASHBURNE, Technical Editor

CONTENTS - NOV., 1936, ISSUE

Volume VIII Number 5

Editorial: "I Want a Job!" A Young Man Takes Stock of Himself.....	Hugo Gernsback 263
The Radio Month in Review.....	264
Looking Ahead in the Radio Field....	R. D. Washburne 266
Radio and Public Address at the Berlin Olympics.....	268
Radio Pictorial	269
The New Philco System of Television!....	A. F. Murray 270
Newest Tubes for the Radio Industry.....	J. H. Green 271
Streamlined Mike Is Also a Loudspeaker!	Andrew Halbran 272
International Radio Review.....	273
A Key to Radio as a Vocation.....	W. E. Schrage 274
The Fast-Moving Radio Field.....	Louis L. Credner 276
The Business of "Radio Plastics"	W. E. S. Griswold, Jr. and Don Mason 276
A Special Audio Amplifier for the DX-er	Percy Steelman 277
Newest Developments in Beam-Tube Input and Output Transformers.....	Leon J. Littmann 278
An "Acorn"-Tube Beat-Frequency Oscillator.....	278
How to Make an Oscilloscope—Part IV	Charles Sicuranza 279
Using Headphones in Service Work....	Paul A. Bottorff 280
ORSMA Members' Forum.....	280
Operating Notes	281
The Latest Radio Equipment.....	282
Build this Beginner's 2-Tube A.C.-D.C. Receiver	Guy Stokely 284

An Easily-Built 4-Tube Portable Set	Gustave L. Klein 284
Making a Q-Test Adapter—Part II.....	C. W. Palmer 285
How to Improve Talkies Fidelity—Part II	Lawrence L. Johnson 286
Pros and Cons of Microphone Types.....	John Erwood 287
The Beginner in Public Address.....	E. L. Melton 287
Introducing—An "Automatic" A.V.C. Beam Amplifier	A. C. Shaney 289
A Complete Oscilloscope "Servicer".....	D. E. Johnson 288
How to Make a Direct-Impedance Bass Booster— Part II.....	L. M. Barcus 289
Putting New Tricks into Old Sets—Part I	R. L. Dougherty 290
Electronic Music Fundamentals—Part VI	Edward Kassel 291

RADIO-SERVICE DATA SHEETS:

No. 181—Detrola Model 105C 5-Tube Dual-Band A.C.-D.C. Superheterodyne; International Model 500 5-Tube Dual-Range Battery Superhet.	292
No. 182—Zenith 6-Tube All-Wave Superhet. Chassis, No. 5634; Fairbanks-Morse 9-Tube All-Wave Model 91 Superhet. Chassis	294
Technicians' Data Service.....	296
Book Reviews	307

SPECIAL EXPERIMENTERS' NUMBER

Every radio man is at heart a radio experimenter, whether he just dabbles in set building as a hobby or if he is a serious development worker. Therefore, every radio man will find much interesting information in the December Special Experimenters' Issue of RADIO-CRAFT—which is filled to overflowing with the latest developments in new circuits, parts, sets, amplifiers, radio dynamic units, etc. Reserve your copy now, at your local newsstand!

Published by Radcraft Publications, Inc. Publication office: 29 Worthington Street, Springfield, Mass. Editorial and Advertising Office: 99 Hudson Street, New York City. Chicago Advertising Office: L. F. McClure, 919 North Michigan Avenue, Chicago, Ill. Western Advertising Office: Loyd B. Chappell, 511 So. Alexandria St., Los Angeles, Calif.

Foreign Agents:

London—Gorrings American News Agency, 9A Green St., Leicester Square, W. C. 2.
 Paris—Messageries Dawson, 4 Rue Faubourg, Poissonniere, France.
 Australian Agent: McGill's Agency, 179 Elizabeth St., Melbourne.

RADIO-CRAFT is published monthly, on the first of the month preceding that of date; subscription price is \$2.50 per year in U. S. and Canada. (In foreign countries, \$3.00 a year to cover additional postage.) Entered at the post office at Springfield as second-class matter under the act of March 3, 1879.

Text and illustrations of this magazine are copyright and must not be reproduced without permission of the copyright owners.

Copyright 1936. Radcraft Publications, Inc.

A FREE LESSON SHOWED BILL HOW HE COULD MAKE GOOD PAY IN RADIO

BILL, YOU'RE ALWAYS FOOLING WITH RADIO-- OUR SET WON'T WORK-- WILL YOU FIX IT?

I'LL TRY, MARY, I'LL TAKE IT HOME TONIGHT



I CAN'T FIND OUT WHAT'S WRONG-- GUESS I'LL MAKE A FOOL OF MYSELF WITH MARY

HELLO, BILL-- GOT A TOUGH ONE TO FIX? LET ME HELP YOU

HELLO JOE-- WHERE'VE YOU BEEN LATELY-- AND WHERE DID YOU LEARN ANYTHING ABOUT RADIO?

I'VE BEEN STUDYING RADIO AT HOME, BILL, WITH THE NATIONAL RADIO INSTITUTE. YOU OUGHT TO TAKE THEIR COURSE. I'VE GOT A GOOD RADIO JOB NOW. LET'S MAKE A CIRCUIT DISTURBANCE TEST-- STARTING WITH THE AUDIO OUTPUT STAGE AND TESTING EVERY STAGE RIGHT BACK TO THE ANTENNA. LISTEN FOR THE CLICKS WHEN I TAP THE GRID LEADS

SAY-- WHERE DID YOU LEARN THAT TEST? IT'S A GOOD ONE



HERE'S THE TROUBLE, BILL, IN THE FIRST I.F. AMPLIFICATION STAGE. I LEARNED THAT TEST EVEN BEFORE I STARTED TAKING THE COURSE, BILL. IT'S DESCRIBED IN A FREE LESSON WHICH THE NATIONAL RADIO INSTITUTE SENDS YOU WHEN YOU MAIL A COUPON FROM ONE OF THEIR ADS

I'VE SEEN THEIR ADS BUT I NEVER THOUGHT I COULD LEARN RADIO AT HOME-- I'LL MAIL THEIR COUPON RIGHT AWAY

I'M CONVINCED NOW THAT THIS COURSE IS PRACTICAL AND COMPLETE. I'LL ENROLL NOW

AND THEN I CAN MAKE REAL MONEY SERVICING RADIO SETS

OR INSTALL AND SERVICE LOUD SPEAKER SYSTEMS

OR GET A JOB WITH A RADIO BROADCASTING OR TRANSMITTING STATION

AVIATION RADIO, POLICE RADIO, TELEVISION, ELECTRONIC CONTROLS-- RADIO IS SURELY GOING PLACES. AND THE NATIONAL RADIO INSTITUTE HAS TRAINED HUNDREDS OF MEN FOR JOBS IN RADIO



YES, I WILL SEND YOU MY LESSON ON RADIO SERVICING TIPS FREE TO SHOW YOU HOW PRACTICAL IT IS TO TRAIN AT HOME FOR A GOOD RADIO JOB



YOU CERTAINLY KNOW RADIO SOUNDS AS GOOD AS THE DAY I BOUGHT IT.

THANKS! IT CERTAINLY IS EASY TO LEARN RADIO THE N.R.I. WAY. I STARTED ONLY A FEW MONTHS AGO, AND I'M ALREADY MAKING GOOD MONEY.



THIS SPARE TIME WORK IS GREAT FUN AND PRETTY SOON I'LL BE READY FOR A FULL TIME JOB

OH BILL-- I'M SO GLAD I ASKED YOU TO FIX OUR RADIO. IT GOT YOU STARTED THINKING ABOUT RADIO AS A CAREER, AND NOW YOU'RE GOING AHEAD SO FAST

OUR WORRIES ARE OVER. I'M MAKING GOOD MONEY NOW, AND THERE'S A BIG FUTURE AHEAD FOR US IN RADIO



I HAVE TRAINED MANY MEN TO START A SPARE TIME OR FULL TIME RADIO SERVICE BUSINESS WITHOUT CAPITAL

Do you want to make more money? I'm so sure that I can train you at home in your spare time for a good Radio Job that I'll send you a sample lesson absolutely FREE. Examine it, read it, see for yourself how easy it is to understand even if you've never had any technical experience or training.

Many Radio Experts Make \$30, \$50, \$75 a Week

Radio broadcasting stations employ engineers, operators, station managers and pay up to \$5,000 a year. Spare time Radio set servicing pays as much as \$200 to \$500 a year. Full time Radio servicing jobs pay as much as \$30, \$50, \$75 a week. Many Radio Experts own and operate their own full time or part time Radio sales and service businesses. Radio manufacturers and jobbers employ testers, inspectors, foremen, engineers, servicemen, paying up to \$6,000 a year. Radio operators on ships get good pay and see the world besides. Automobile, police, aviation, commercial, Radio, and loud speaker systems offer good opportunities now and for the future. Television promises many good jobs soon. Men I have trained are holding good jobs in all these branches of Radio.

Many Make \$5, \$10, \$15 a Week Extra In Spare Time While Learning

Practically every neighborhood needs a good spare time serviceman. The day you enroll I start sending you Extra Money Job Sheets. They show you how to do Radio Repair jobs that you can cash in on quickly. Throughout your training I send you plans and ideas that have made good spare time money-- from \$200 to \$500 a year--for hundreds of fellows. I send you special Radio equip-

ment and show you how to conduct experiments and build circuits which illustrate important Radio principles. My training gives you practical Radio experience while learning.

J. E. SMITH, President National Radio Institute

Get My Lesson and 64-Page Book FREE--Mail Coupon. In addition to my Sample Lesson, I will send you my 64-page Book, "Rich Rewards in Radio." Both are free to my fellow over 19 years old. My book describes Radio's spare time and full time opportunities and those coming in Television; tells about my Training in Radio and Television; tells about my Money Back Agreement; shows you actual letters from men I have trained, telling what they are doing and earning. Find out what Radio offers YOU! MAIL THE COUPON in an envelope, or paste it on a penny postcard--NOW!

J. E. SMITH, President National Radio Institute Dept. 6MX Washington, D. C.

MAIL THIS NOW

THIS FREE BOOK HAS HELPED HUNDREDS OF MEN MAKE MORE MONEY



J. E. SMITH, President, Dept. 6MX National Radio Institute, Washington, D. C.

Dear Mr. Smith: Without obligation, send me your service manual "Radio Receiver Troubles--Their Cause and Remedy" and your free book about the spare time and full time Radio opportunities, and how I can train for them at home in spare time. (Please write plainly.)

Name Age

Address

City State 14x1

Be Prepared to Meet All Radio Servicing Emergencies

WITH GERNSBACK OFFICIAL RADIO SERVICE MANUALS



Just as we say—"Be prepared to meet all radio servicing emergencies with the Gernsback Official Radio Service Manuals." You never know when a service job requires that "extra" special attention. It might mean the difference between doing the job or losing it. You're safe if you have on hand the GERNSBACK MANUALS—either for regular service work or for servicing auto-radios. Get your copy today! No other radio book is comparable to the new 1935 OFFICIAL RADIO SERVICE MANUAL. In contents, in style of printing, in grade of paper, in illustrations, there has never been published such a comprehensive volume.

This Manual contains over a thousand pages—yet it is only 1 1/4 inches thick because it is printed on a special Bible stock which is an exceptionally good stock, yet one of the thinnest and most durable papers. This 1935 Manual is the most authentic and elaborate service guide ever used in the radio industry.

Contents of the 1935 Manual

Over 1,000 pages full of diagrams and essential information of manufactured receivers—only data of real use in servicing is included. This new Manual is really portable since it is extremely thin and light as well. ● Volume V continues where the preceding manual left off. ● Many circuits of old sets are included. ● Service Men know every set has certain weak points which are really the cause of trouble. Wherever the information could be obtained, these weaknesses with their cures are printed right with the circuits. This is an entirely new and valuable addition to the Manual. ● All the latest receivers are included—all-wave sets, short-wave sets, auto-radio sets, midset and cigar-box sets, etc., as well as P.A. Amplifiers and equipment, and commercial serv-

icing instruments. ● The cumulative index is even more complete than before; including cross-references to sets sold under different names and type numbers. ● Volume V includes resistance data; socket layouts; I.F. data; and voltage data. ● Tube data on latest tubes. ● Free question and answer service—as included in our last three manuals.

OVER 1000 PAGES
Over 3,000 Illustrations
Size 9" x 12"—only 1 1/4" thick
Flexible, looseleaf leatherette cover

SET SERVICING
Service information found in the Manuals covers all types of radio receivers. The material is extremely valuable to Dealers and Service Men. On many diagrams appear voltage readings of tubes, socket connections, transformer data, alignment details, and other service notes.

PUBLIC ADDRESS
The pages on P.A. Installation will be helpful to Service Men and P.A. specialists. Such prominent features as class A and B amplifiers—single and dual channel systems—attenuators, and mixers—super-power stages—pre-amplifiers and other commercial devices for P.A. work are included.

ALL-WAVE RECEIVERS
Information relative to short-wave receivers have found their way into the Manuals. For these standard manufactured sets wherever possible complete aligning details for all wave bands are included in addition to the service material listed for other sets.

AUTO-RADIO RECEIVERS
All available service information on new auto-radio sets has been included. From this data alone Service Men could derive sufficient knowledge to venture in a specialty field—that of servicing only auto-radios.

\$7.00 LIST

Which of These GERNSBACK RADIO SERVICE MANUALS

Do You Need to Complete Your Files

1934 Official Radio Service Manual
Over 400 Pages, 9x12 Inches
Over 2,000 Illustrations
Flexible, Looseleaf, Leatherette Cover
List Price \$3.50

1933 Official Radio Service Manual
Over 700 Pages, 9x12 Inches
Over 2,000 Illustrations
Flexible, Looseleaf, Leatherette Cover
List Price \$5.00

1932 Official Radio Service Manual
Over 1,000 Pages, 9x12 Inches
Over 2,000 Illustrations
Flexible, Looseleaf, Leatherette Cover
List Price \$5.00

1931 Official Radio Service Manual
650 Pages (Including Supplements)
9x12 Inches
Over 1,500 Illustrations
Flexible, Looseleaf, Leatherette Cover
List Price \$4.50 (Including Supplements)

1933 Official Auto-Radio Service Manual (Volume I)
Over 200 Pages, 9x12 Inches
Over 500 Illustrations
Flexible, Looseleaf, Leatherette Cover
List Price \$2.50

—for the real auto-radio servicing "dope," you can't find a better book!

The 1935 Official Auto-Radio Service Manual

Every radio man connected in any way with the booming auto-radio business needs a copy of the new OFFICIAL AUTO RADIO MANUAL. It contains only auto-radio service "dope."

HERE ARE HIGHLIGHTS OF THE 1935 AUTO-RADIO SERVICE MANUAL

240 pages crowded with diagrams, service material and other essential data required for proper servicing of new auto-radio receivers. Included are diagrams of sets which appeared during 1934, and which were not included in the supplement to the first edition. Complete schematic diagrams, chassis layouts, voltage tabulations and servicing instructions are included for practically all sets. "Under-side" tube symbols are also included to facilitate the job of servicing the set. Instructions are included with many sets telling how to suppress stubborn cases of ignition interference. This includes the newest "suppressors" sets—and what to do when interference is encountered with this type of set. Details on how to make installations in "turret-top" cars are included. The different methods used by car makers and set manufacturers are listed with the individual circuits and service information. The index contains the listing of sets which were published in the first edition, as well as the sets which appear in the new volume. This information helps the Service Man to locate the circuit and details for any receiver that has been made. The book is bound in a handy, flexible leatherette cover. To be sure the pages are sturdy, to withstand constant use, the book is printed on a special "bible" stock. This is a very durable, but thin paper. The book printed on this paper can be easily rolled to fit into your pocket or slipped in the service kit.



240 Pages
Over 500 Illustrations
Size 9 x 12"

Flexible, Looseleaf Leatherette Cover

\$2.50 LIST

MAIL COUPON TODAY FOR ANY MANUAL!

GERNSBACK PUBLICATIONS, Inc. RC-1136
99 Hudson Street, New York, N. Y.

Enclosed you will find my remittance of \$..... for which please send me promptly, POSTPAID, the OFFICIAL RADIO SERVICE MANUAL indicated.

- | | |
|---|---|
| <input type="checkbox"/> 1935 Edition at \$7.00 | <input type="checkbox"/> AUTO-RADIO MANUALS |
| <input type="checkbox"/> 1934 Edition at \$3.50 | <input type="checkbox"/> 1935 Edition at \$2.50 |
| <input type="checkbox"/> 1933 Edition at \$5.00 | <input type="checkbox"/> 1933 Edition at \$2.50 |
| <input type="checkbox"/> 1932 Edition at \$5.00 | |
| <input type="checkbox"/> 1931 Edition at \$4.50 (Including Supplements) | |

Name

Address

City State.....

(Send remittance by check, money order, or registered letter if it contains cash, currency or unused U. S. Postage Stamps.)

GERNSBACK PUBLICATIONS, Inc.

99 Hudson Street

New York, N. Y.

OVERSEAS READERS!

These books can be obtained from the following houses:

GREAT BRITAIN
Gorrings, 9a, Green Street, Leicester Square, London, England

FRANCE
Editions Radio, 42 Rue Jacob, Paris

AUSTRALIA
McGill's 183-195, 218 Elizabeth St., Melbourne, C. I

Please Say That You Saw It in RADIO-CRAFT

NOW IS THE TIME TO CASH IN ON THE MOST SENSATIONAL HOME TRAINING PLAN IN THE HISTORY OF RADIO



Make Me Prove That Only
17c a Day The Mere Cost of a
Pack of Cigarettes

ACTUALLY SETS YOU UP FOR BUSINESS

RIGHT NOW!.... Is the Time to Get Started in an Industry That is Making Fortunes for Live, Wide Awake Men.



I can teach you QUICKLY
No previous experience required

I want to add my personal assurance that no matter what sort of work you have been doing... no matter how limited your past experience in Radio... my practical, home study course will thoroughly fit you for a useful and profitable career. There is no guess work about this. It is FACT!

You will be amazed at how quickly you will grasp the fundamentals of modern RADIO... it is really very easy to learn. My course has been planned to give you just what you need—in logical sequence—it's easily understood... entirely pleasing and interesting... the best TRAINING value you will find anywhere in the country. Be sure to write for my latest FREE booklet "YOUR FUTURE IN RADIO." Fill in the coupon and mail TODAY!

F. L. Sprayberry

THIS new and different kind of Training does more than teach you about all branches of Radio. It teaches you Radio business methods—it sets you up ready for an actual start in business—and it backs up every step of your training with REAL PROFESSIONAL RADIO EQUIPMENT!

No matter what kind of Radio Training you take, it is absolutely necessary that you have equipment of this kind BEFORE you are ready to start making real money.

Sprayberry Training brings it to you almost at the start—teaches you just how to use it under actual working conditions. Upon completion you have COMPLETE business and technical training PLUS the needed equipment to enter business at once for full or part time profits—or to start off on a career in any one of Radio's specialized fields such as Public Address, Auto Radio, Commercial Radio, Broadcasting, etc.

ACT TODAY

Get Into Radio—An Industry That Shows a Profit NOW!

Radio is going ahead by leaps and bounds. And now TELEVISION is on its way!

Today is the time to get started—and Sprayberry Training will start you right. Investigate at once! I will show you how an investment of only 17c a day—just about the cost of a pack of cigarettes—can mean a real future for you in one of the fastest-growing professions in the world.

READ WHAT OTHERS SAY ABOUT THE FAMOUS SPRAYBERRY TRAINING



A. H. LANDOIE, Northbridge, Mass., writes: "Since enrolling I have cleared a net profit of more than \$150 in spare time alone... and I am not half through the course yet. Honestly, I cannot understand how you can give so much 'dope' for so little money."

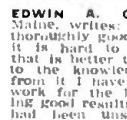

EDWIN A. GAMMON, Auburn, Maine, writes: "Your course is so thoroughly good and practical that it is hard to pick out one part that is better than any other. Due to the knowledge I have gotten from it I have been deluged with work for the last month, achieving good results with radios which had been unsuccessfully tackled by other service men. You deserve all the credit, and I can't tell you how much I appreciate your course."



WALTER DAVIS, Baltimore, Md., writes: "Thanks to the Sprayberry Practical Course (for which I would not take anything or any price) I am now making on an average of from \$10 to \$25 per week in spare time work, and if this keeps up I may go in for full time radio servicing and sales. Thank you again."



YOU GET ALL OF THIS PROFESSIONAL RADIO EQUIPMENT

The Sprayberry Academy of Radio is the only school which furnishes you with COMPLETE Radio equipment—necessary for starting your own business. This makes it much easier for you to learn Radio thoroughly. That is why students make extra money on Radio work even before completing their Training.

SPRAYBERRY ACADEMY OF RADIO

F. L. Sprayberry, President
2545 University Place, N. W., Washington, D. C.

Without obligation on my part please send your book "MY FUTURE IN RADIO" and other details of famous Sprayberry Training.

Name

Address

Paste this coupon on a penny post card and mail TODAY

NOTE: Your future is the most important thing in the world to you. Before enrolling for ANY home study course you owe it to yourself to investigate the many unique advantages of Sprayberry Training.

HERE'S THE

Newest



A COMPLETE NEW LINE
OF RADIO TEST EQUIPMENT
from \$17.95 to
\$147.95

S U P R E M E I N S T R U M

EXPORT DEPT., ASSOCIATED EXPORTERS CO., 145 W. 45th

thing IN RADIO!

Mr. Service Man:

The new 1937 SUPREME Instruments are on parade -- a price range from \$17.95 to \$147.95 -- greater values than ever! For example -- the Model 590 -- seven A. C. voltage ranges of 0/5/25/125/250/500/1250/2500 volts; seven D. C. voltage ranges of 0/5/125/250/500/1250/2500 volts; seven output ranges of 0 to +16, +10 to +26, +20 to +36, and +30 to +46 decibels; six D. B. ranges - 10 to 500/1250/2500 volts; five D. C. milliamperes ranges of 0/12.5/25/50/100/250/500/1250 M. A.; one microampere range of 0/250 microamps; one ampere range of 0/12.5 amps; twelve capacity ranges of 0/0.0125/0.025/0.05/0.125/0.25/0.5/1.25/2.5/5.0/12.5/25.0/50.0 mfd; and five resistance ranges of 0/1,000/10,000/100,000/1,000,000/10,000,000 ohms from self-contained batteries. Ranges to cover all necessary test work in any receiver, transmitter or speech equipment. The 0-200 microampere Quadrimeter -- the newest thing in Radio. All for only \$46.95. Write for catalog or come in today and see the world's finest radio Testing Equipment.

Your Parts Jobber

SUPREME INSTRUMENTS

**YOU CAN BUY ANY
SUPREME INSTRUMENT
ON S. I. C. EASY TERMS**

**ENTS CORP. GREENWOOD
STREET, NEW YORK, N. Y., CABLE ADDRESS: LOPREH, N. Y. MISS., U. S. A.**

Only in CORNELL-DUBILIER Condensers



ONLY in Cornell-Dubilier dry electrolytics will be found the high formation process of manufacture. This engineering development, put into operation after many years of study, research and laboratory reproduction of actual field operating conditions assures maximum operating efficiency, long dependable service, positive customer satisfaction.

• Descriptive catalog available on request. Manufacturers of the World's finest Condensers for more than a quarter of a century.

THE TYPE EB single and multiple section electrolytics are assembled in inverted cylindrical aluminum containers with wire lead terminals. Dual section units are now available in a complete variety. Common positive, common negative, separate sections and other important types required to meet any condition in the field, available in a complete capacity range.

TYPE EP single and multiple section electrolytics in inverted metal containers with lug terminal assembly. Container common negative and terminal lugs color coded as to capacity.

THE TYPE EA series, in upright aluminum containers is particularly suited for the thousands of out-of-date receivers that can be quickly and economically rehabilitated with these units.

TYPES EE AND EH cardboard container electrolytics are available with either lug or lead terminals, in both multiple and single capacity units.

TYPE ED cardboard tubular electrolytics are hermetically sealed and embody the most advanced engineering principles. Small, compact, efficient, equipped with wire lead terminals, polarity clearly indicated on cartridge, these capacitors are available in a complete range of voltages and capacities for every need.

Look for the C-D display at your local jobber illustrating in complete detail the entire Cornell-Dubilier line of radio servicing condensers.

MICA • PAPER • DYKANOL WET & DRY ELECTROLYTICS



1014 HAMILTON BLVD.

SO. PLAINFIELD, N. J.

ACA ASTOUNDS the P. A. FIELD

with 9 Amazing Engineering Developments!

Out of the ACA Laboratory comes a series of revolutionary engineering contributions. Analyze what other amplifier manufacturers have done for you—and you must admit that no other line has been marked by as many notable advances as ACA, in the past ten years.

- (1) First Anti-Howl Amplifier; (2) First Automatic Audio Volume Control;
- (3) First Floating Audio Power; (4) First Automatic Volume Compressor;
- (5) First commercial 6L6 Beam Power Amplifier; (6) First Anti-Microphonic Circuit;
- (7) First Cathode-Ray Audio Control Indicator; (8) First Self-Contained Volume Expander;
- (9) First Synchronous High and Low Frequency Complimentary Attenuator.

These are but a few of the outstanding improvements exclusively incorporated into the design of ACA Amplifiers which make them today's best buy for every P.A. industrial, educational, commercial, institutional and electioneering applications.

All ACA Amplifiers are designed by A.C. Shaney; built under his personal supervision; unconditionally guaranteed by ACA for FIVE YEARS; available for FREE TRIAL and offered at a price well within the reach of all potential users.

ACA offers you a wide selection from a complete line of "Citation Series" of Gold Medal Amplifiers. See these truly great amplifiers at your jobber's today. A request on your letterhead or the coupon will bring you all the details.

FREE TECHNICAL HELP: Whatever your P.A. problem may be, Mr. A. C. Shaney, Consulting Engineer, (famous author and international authority on public address systems) will be glad to help you plan a perfect sound system for your particular requirements, entirely free of charge.

Correspondence is invited from servicemen, P.A. technicians, dealers, distributors, jobbers, factory representatives, manufacturers, and engineers.

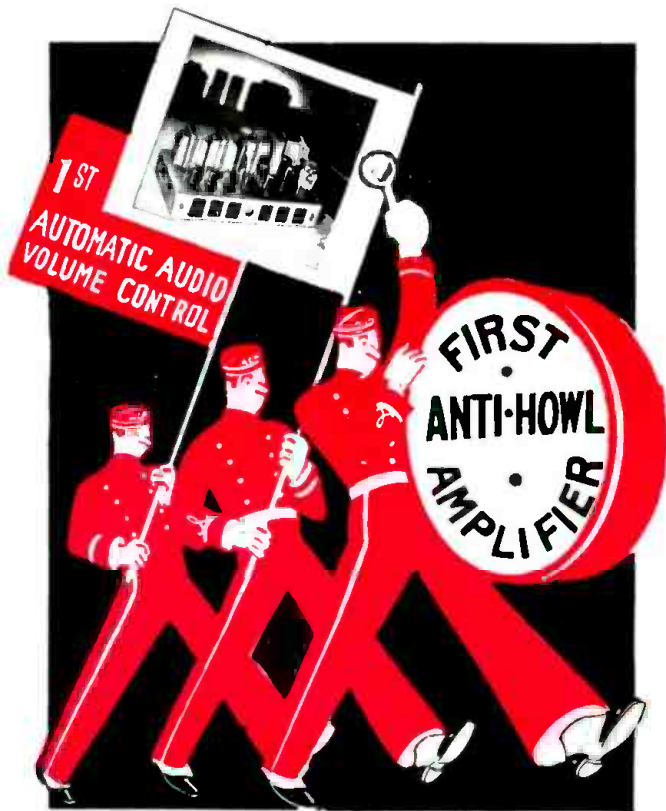

MAIL THIS COUPON Today

AMPLIFIER CO., of AMERICA

20 W 22ND STREET NEW YORK CITY

Add my name to your mailing list to receive your latest P.A. Engineering Bulletins as soon as they are released.

I am enclosing a 3c stamp for which, please send your latest catalogue of Gold Medal Amplifiers and details of your Free Trial Offer.

NAME

ADDRESS

CITY STATE

AMPLIFIER CO., of AMERICA

20 WEST 22ND STREET NEW YORK CITY

PUBLIC ADDRESS DIVISION

JUST OUT!

Official Radio Service Handibook by J. T. Bernsley

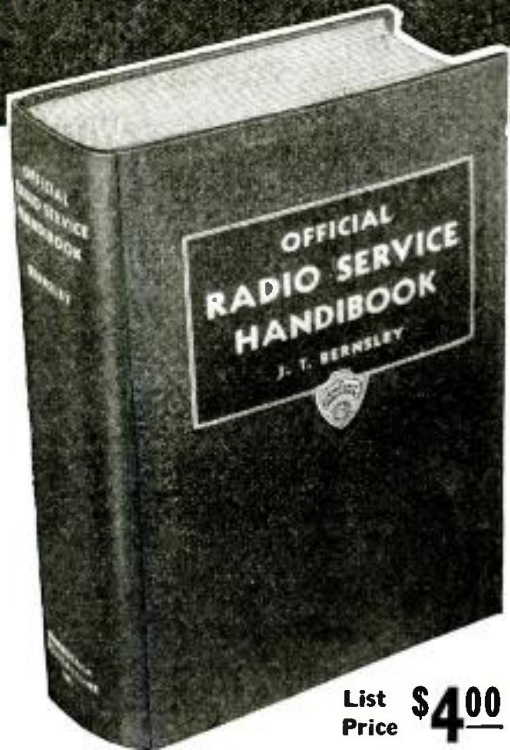

List Price **\$4.00**

OVER 1,000 PAGES
OVER 1000 ILLUSTRATIONS
6 x 9 inches
Beautiful Leatheroid Cover

*The Most "Up-to-the-Minute"
Book for Radio Men!*

HERE'S the book on radio servicing that's just out. It contains everything Service Men must know. The book, OFFICIAL RADIO SERVICE HANDBOOK, is edited by J. T. Bernsley, foremost radio service authority. This 1936 service guide is the only book of its kind—its editorial material has been prepared that the technical information can be understood by even beginners in radio servicing. Every page contains new material, new illustrations—no reprinted literature or rehashed articles.

Over a thousand actively engaged Service Men have helped prepare the service data found in the OFFICIAL RADIO SERVICE HANDBOOK. Their contributions, in the form of service notes, short cuts, and trade secrets make this book the outstanding volume on radio servicing ever to be published.

The OFFICIAL RADIO SERVICE HANDBOOK covers thoroughly over 500 radio topics. It tells you how to analyze the latest commercial receiver circuits; how to really make money servicing midget sets; and, how aligning supers can be made easy. It stresses the many uses of different types of test equipment; it gives you short cuts in trouble-shooting and repairing; and contains over 250 pages of operating notes on 1,000 manufactured receivers. So up-to-date is the OFFICIAL RADIO SERVICE HANDBOOK that it explains thoroughly what to do when a receiver with the "Magic Eye" goes "cockeyed."

Hundreds of Service Men have already ordered their copy of this great radio service guide. Order your copy NOW if you have not already done so.

Partial Contents of this Great Book

PART 1—CIRCUIT THEORY AND ANALYSIS

R.F. Fundamentals; Superheterodyne Receiver Theory; A.V.C. and Tuning Indicator Circuits; A.F. Fundamentals; Power Supply Theory and Circuits; Speakers, Reproducers and Pick-Ups; Commercial Receiver Circuits of All Types, How to Analyze.

PART 2—MODERN SERVICING AND TEST EQUIPMENT

Fundamentals of Metering and Test Equipment; Standard Servicing Instruments; The Cathode Ray Oscillograph and Associate Instruments; How to Build Essential Servicing Test Instruments.

PART 3—PRACTICAL SHORT-CUTS IN TROUBLE SHOOTING AND REPAIRING

Localizing Trouble by Inspection Methods; Short-Cuts with Test Instruments; How to Quickly and Properly Perform All Types of Repairs; Unusual Servicing Experiences; Tube Troubles and Characteristics.

PART 4—SPECIALIZED RECEIVER AND INSTALLATION DATA

All-Wave and High Fidelity Receiver Servicing and Installation Data; Auto Radio Receiver and Installation; Specialized Servicing and Installation (Remote Tuning Controls, Home Recording, Automatic Record Changers, Apartment House Antennas, etc., etc.); Eliminating Noise Interference.

PART 5—MODERNIZATION AND CONVERSION DATA

Modernizing and Improving Methods for All Types of Receivers; Converting A.C. Receivers for D.C. Operation and Vice Versa.

PART 6—SOCIAL AND ECONOMIC PROBLEMS OF THE SERVICE MAN

Improving Knowledge and Technique; Social Problems—How to Organize. Listing of Servicemen's Organizations; The Future of the Servicing Profession.

PART 7—OPERATING NOTES AND PRACTICAL DATA LISTINGS

Operating Notes on Over 1,000 Receivers; I.F. Peaks of Approximately 3,000 Receivers; Voltage Dividers for 300 Receivers, Speaker Field Listing; Radio Mathematics and Measurements.

OVER 250 PAGES OF OPERATING NOTES

Whether it is a fading job, lack of sensitivity, noise within the receiver, aligning a chassis, poor A.V.C. action or any other trouble that is usually the "bugaboo" of most service Men, you will find the symptoms and remedy clearly described in OFFICIAL RADIO SERVICE HANDBOOK. The exact procedure for repairing, as well as the characteristic trouble in almost all models of manufactured sets, will be found in the section on OPERATING NOTES—over 250 pages of this data, the most important information to any radio man in the servicing field. The material in this section has been arranged, as well as classified, so there is no difficulty in immediately locating the necessary information.

CLIP—MAIL COUPON TODAY!

GERNSBACK PUBLICATIONS, Inc. RC-1136
99 Hudson St., New York, N. Y.

Gentlemen: Enclosed you will find my remittance of \$4.00 for one copy of the OFFICIAL RADIO SERVICE HANDBOOK. YOU ARE TO SEND THIS BOOK TO ME POSTAGE PREPAID.

Send me handbook C.O.D.

Name

Address

City State

(We accept cash, stamps, money orders or U.S. checks in connection with this offer. If you send cash, be sure to register your letter.)

GERNSBACK PUBLICATIONS, Inc.
99 Hudson Street New York, N. Y.

OVER WITH A

BANG

THE WESTON

MODEL 772

Super-Sensitive Analyzer

PRICE \$ **46** ⁵⁰/_{NET} TO DEALERS
IN U. S. A.

**THE NEW WESTON ANALYZER . . . WITH
SENSITIVITY OF 20,000 OHMS PER VOLT,
MEETS WITH OVERWHELMING RESPONSE—
servicemen won't take less!**



Announced but one month ago, the new WESTON Model 772 Super-Sensitive Analyzer is sweeping the service field. With sensitivity of 20,000 ohms per volt . . . with resistance ranges usable up to 30 megohms . . . with current measurements as low as 1/2 microampere . . . with a wide range of usefulness, including *all* radio receivers, old or new; television sets, amplifiers, sound movies, P.A. systems and photo-cell circuits . . . with a big, super-sensitive WESTON Meter . . . and, above all, being WESTON built throughout, it's no wonder that servicemen, everywhere, are equipping with this new device. For there is nothing that compares with Model 772, except in laboratory instruments, and at laboratory prices.

THE WESTON MODEL 771 CHECKMASTER

Compact . . . attractive . . . tests all present tubes—neon short check—voltage ranges for point-to-point testing—resistance ranges for continuity testing, etc. For counter and portable use.

PRICE \$ **45** ⁰⁰/_{NET} TO DEALERS
IN U. S. A.



Be sure you get full particulars on Model 772 before you buy any set tester. Also, be sure to get complete information on the WESTON Model 771 Checkmaster, the portable tube checker equipped for quick and dependable trouble shooting. Return the coupon today . . . Weston Electrical Instrument Corporation, 599 Frelinghuysen Ave., Newark, N. J.

WESTON
Instruments

Weston Electrical Instrument Corp.,
599 Frelinghuysen Ave.,
Newark, N. J.

Rush me bulletin on the new Super-Sensitive Analyzer,
and the Checkmaster.

NAME _____
ADDRESS _____
CITY _____ STATE _____



"Takes the Resistance out of Radio"

Editorial Offices: 99 Hudson St., New York, N. Y.

HUGO GERNSBACK, Editor

Vol. VIII, No. 5, Nov. 1936

"I WANT A RADIO JOB!"

A Young Man Takes Stock of Himself

An Editorial by HUGO GERNSBACK

THERE must be something radically wrong with me!

Here I have been trying to secure a position in my favorite line of endeavor—Radio, but so far I have drawn nothing but blanks. Wherever I go, it is always the same old story: "Nothing just now. We'll take your name in case we should have an opening." That is as far as I ever seem to get.

I have gone to employment agencies, telling them I wish to be located in radio. I have gone to broadcast studios, radio factories and radio laboratories, vacuum-tube manufacturers, and to radio publishers, and left no stone unturned, but the answer always was uniformly the same: "No opening."

Yet I *know* there are jobs to be had. Dick Smith, one of my former pals, didn't seem to have much trouble to get located in a small laboratory of a local radio set manufacturer. John Dale, another one of the old gang, got a marvelous job in the transmitter room of a local broadcast station. And, as I look back upon it now, it did not seem to take them very long to get the jobs either. Evidently the fault lies with me . . . not the radio industry.

Perhaps, when I come to think of it, I don't know just what sort of a radio job I'm looking for. Of course, I know that the radio industry is pretty big, and that there are literally thousands of branches, but my main trouble seems to be that I can't make up my mind just *where* I fit. I know I have a pretty good education, and I know radio from the ground up, having started at it when I was seven years old. I know radio circuits backwards and forwards. I read all the radio magazines in sight, yet for the life of me, I can't see into what branch of radio I would fit best. I have a pretty good book library which contains the best radio volumes but evidently that does not seem to be sufficient.

And then the employers are always asking what actual radio experience I have had. Never having been employed, I naturally haven't got any. Perhaps that is what is holding me back. The superintendent of a radio plant suggested that I take a job without pay for a few weeks, just to get the experience. That is not such a bad idea and I may take his advice.

Another one handed me a questionnaire, and, as I now remember, I flunked in four points: (1) mathematics; (2) a purely electrical problem that had nothing to do with radio; (3) a question on physics, also unrelated to radio; (4) no previous radio experience.

MANY young men fail in securing positions these days mainly due to their own shortcomings. The following imaginary stock-taking by one of them is a composite of ideas gathered in interviewing applicants and from letters received during the past few months by the editor.

Perhaps I should have taken a radio resident- or mail-order-school course, which probably would have saved me three of the four points where I couldn't make the grade. Perhaps my knowledge wasn't

broad enough, and perhaps employers want a little more besides just radio knowledge.

What else can be wrong with me? I know I'm a poor salesman when it comes to putting over my own virtues. Evidently that doesn't pay these days—perhaps I shouldn't be so timid and mouselike. I naturally am an introvert, and that type of person always seems to set their worst foot forward. I must make up my mind at the very next interview to talk right out and not let the fellow behind the desk fall asleep. It seems to be no use these days to hide one's own light.

What about my personal appearance? Yes, I admit that perhaps Dick Smith was a better dresser and was more careful in his appearance than I am. That is also true of John Dale. So, if I spruce up a bit maybe Mr. Employer will take more kindly to me.

There seem to be other things wrong with me too. I am reminded of this because only last week when I answered an advertisement for a Radio Salesman, the fellow with the eyeglasses behind the desk seemed to get the impression that I was "not the type." Just what he meant by that, I didn't have the nerve to ask, but evidently my timid bearing and my scared face wasn't the type he wanted. But perhaps I can overcome these handicaps with a little practice.

And while my knowledge in radio is pretty broad, I must confess that it is not 100 per cent; or anywhere near a high mark, when it comes to any specialized subject. Perhaps the world requires specialists, so what I am going to do right now is to sit down and make up a list of twenty-five different radio subjects and check off the ones in which I am most interested. Next, I am going to learn all I possibly can on those few subjects, and then I am going to hike right over to the nearest employer in that branch and get a job, by hook or by crook, even if I have to work for nothing for a month in order to gain that important experience! And perhaps, if Mr. Employer sees how earnest I am about getting into his place, maybe he wouldn't want me to work for nothing, and with a bit of perseverance I'll land the job anyway. That is my resolution and I'm going to stick to it.

THE RADIO MONTH



POCKET 2-WAY POLICE RADIO

THE police force of Brighton, England has been experimenting with pocket radio for some time, having equipped its patrolmen with pocket receivers, some 2 years ago.

Last month, however, they tried out a 2-way system using pocket *transceivers* operating on ultra-high frequencies, so that the "bobbies" could talk back.

According to reports, this new system proved entirely successful, with a few minor exceptions. It is expected to speed up police work tremendously, by maintaining perfect contact between headquarters and the men on beat.

Inquiries in New York revealed that the metropolitan police have been experimenting with pocket- and belt-radio equipment for some time but found the battery expense too great for general use—they are watching development carefully, though.

DUN AND BRADSTREET'S REPORT

THE report of Dun and Bradstreet covering the first 6 months of 1936 which was published last month, revealed several conditions which are exceedingly optimistic.

During this period, *radio sets were turned out at a faster rate than during any other period in the history of the radio business!* Console models of the better quality comprised the bulk of the output as interest in midgets and cheaper consoles waned. The production of auto radio sets for the 6 months equalled the entire output in 1935.

Factories have been running 4 to 6 weeks behind their shipping dates!



Above, the appearance of the French International Exposition—featuring radio. Left, wife of the police chief of Brighton (Eng.) talking over the pocket radio system.

RADIO IN PARIS EXPOSITION

THE importance of radio in business, industry and everyday life has been demonstrated in numerous ways during the past few years. Recent scientific expositions have particularly stressed this fact—as many of the displays were either concerned with radio or electronic subjects, or the displays themselves operated by electronic means.

Last month, in announcing completion of plans to hold a huge International Exposition in Paris, the importance of radio was again demonstrated as the Exposition will not only be well represented throughout with radio and electronic items, including the featured "Radio-Palace," but the entire Exposition is built around the Eiffel Tower which has been associated recently with television experimentation (having a high-frequency television transmitter installed at its base with the antenna supported on the tower).

RADIO'S MAGIC WORD—MEDICO

ONE day last month, the telephone in the Marine Hospital in New York brought the following message from the S.S. West Caddoa, far at sea:—"Third mate dangerously ill—symptoms nervous shock, heart trouble, seems excitable and faint. Advise means of stimulating heart."

Five minutes later, telephone, telegraph and radio facilities were used to relay instructions from the hospital staff.

This humane service was given as a result of the receipt of the call MEDICO at the Radiomarine Corp. station at Chatham, Mass. The call MEDICO, which is given preference over all other messages except SOS, was inaugurated 15 years ago by the Seaman's Church Institute. Several hundred such "free" calls are handled yearly by the government doctors.

HARBOR RADIO TELEPHONE SERVICE

TWO different systems of harbor radio telephone communication were announced last month. By means of these installations it is possible to talk to the crews of tow boats and other harbor craft at any time either day or night:—thus facilitating boat dispatching.

The first system was announced by Western Electric Co. They have set up a 400-watt, 2,198 kc. transmitter at St. George, Staten Island, N. Y., and several 2,590-kc. receivers at different locations in the vicinity of New York harbor, for 2-way telephony.

This system operates in conjunction with the exchanges of the New York Telephone Co. so that any telephone can be used to call the ships, by simply giving the correct number to the toll operator. By means of selective signaling (similar to the dial telephone) a regular telephone bell on the ship rings when a call is made for that particular ship. A button on the telephone handset puts the boat transmitter on the air when talking from ship to shore. (The tug captains have 3rd-class radio telephone licenses, which do *not* require knowledge of the telegraphic codes.)

A charge of \$3.00 for a 3-minute conversation is made. Installation on the boats costs the owners about \$1,250. Larger 50-watt transmitters are also obtainable. At present, only one channel is available for this service.

The second system was announced by Radiomarine Corp. of America (RCA). This is, so far, a 1-way system, from Radiomarine experimental station W2XBG on 17.1 megacycles, to the receivers on the tow boats. Instructions can thus be made, changed or cancelled from the dispatchers to the boats.



The harbor radio-phone equipment on a tow boat.

IN REVIEW

Radio is now such a vast and diversified art it becomes necessary to make a general survey of important monthly developments. RADIO-CRAFT analyzes these developments and presents a review of those items which interest all.

RADIO—DROUGHT INSTIGATOR?

LAST month, in an issue of *Liberty* magazine, Bernarr Macfadden, publisher of that magazine, wrote an editorial in which he purported to show that radio is the arch villain responsible for all the recent "freak storms, drought, floods and cold winters" (also without doubt, grandmother's lumbago).

It is astounding that a person supposedly so well versed in scientific facts should entertain so childish an idea. Apparently Mr. Macfadden is unaware of the extensive and authoritative investigations which have been made by Government bureaus, which clearly establish the causes of drought and flood conditions. Also, we wonder if Mr. Macfadden blames radio for the extraordinary floods and droughts mentioned in the Bible? Or, in more recent times, the floods of the Hoang-Ho River in China in 1887, or at Johnstown, Pa., in 1889; both of which occurred before "radio"?

It is surprising to what lengths some people will go to prove that a little knowledge is a dangerous thing!

"TONE" BROADCAST FOR MUSICIANS

AT the request of a number of musical organizations, the U. S. Bureau of Standards, last month, sent out a test radio broadcast of the musician's standard "A" tone of 440 cycles per second, day and night for a test period of 2 weeks. This was intended for musical instrument manufacturers, piano tuners and others.

The transmission of this standard "A" will be continued if sufficient interest is shown.

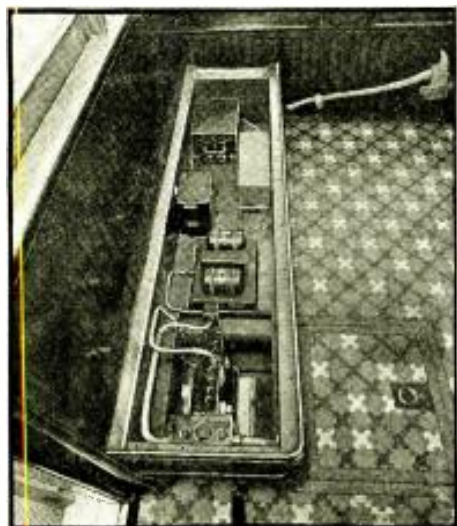

The complete ship transmitting and receiving installation on the tug "Lancaster" of the P.R.R.



Above, radio equipment of the Navy department working in conjunction with the warships Oklahoma and Quincy in rescue work. Right, Jean Parker with the sound reflector.

RADIO IN THE SPANISH REVOLT

ONCE again, last month, radio communication was given a test of its mettle in the rescue of stranded American citizens in war-torn Spain.

An outstanding example of the effectiveness of this communicating medium occurred in connection with Ambassador Claude G. Bowers. For several days after the uprising in Madrid, no word was heard from the Ambassador and it was feared that he might have come to harm. Finally, he spoke directly with the Assistant Secretary of State in Washington, via radio telephone. The State Department announcement following this conversation stated: "The Ambassador explained that he was unable to cross the (French) border to submit telegraphic reports as all traffic, even in diplomatic cars was closed, and that he was depending entirely on radio."

Radio was also employed by the Spanish insurgents in urgent requests from Melilla (the Spanish Moroccan rebel base) for the immediate delivery of anti-cholera serum and hydrophobia serum from Seville by plane.

WARNER BROS. RETURNS TO ASCAP

LAST month marked the termination of 6 hectic months of operating independent of the American Society of Composers, Authors and Music Publishers for Warner Brothers' music publishing subsidiaries.

The agreement between the two dissenting factions brought back on the air many favorite musical selections which have been missed from broadcast programs. It also automatically withdrew over 200 infringement suits started by Warner Brothers against broadcasters.

The exact terms under which Warner Brothers returned were not disclosed.



NOVELTY IN "MOVIE" RECORDING

ANEW device for improving the pick-up of sound from a distance in motion picture recording was perfected last month, to facilitate a difficult job of recording.

The device consists of a parabolic reflector with the microphone fastened at the focal point of the parabola. The sounds within the focus of the reflector are then concentrated at the mike, thus increasing the sound tremendously.

Radio-Craft readers will remember that a similar sort of device was described several years ago, for picking up and recording bird calls!

NEWS BRIEFS FROM HERE AND THERE

DURING the past month a number of news items have appeared which are of interest to radio men.

The Coast Guard tried out a new P.A. system light enough to be installed on a plane, yet powerful enough to shout hurricane warnings over a radius of 1 mile!

Purdue University and National Television Corp. placed the Federal Communications Commission in an embarrassing position by contesting the F.C.C. order to move all television experiments out of the medium frequencies—both outfits claimed to have been sending satisfactory television images on these frequencies for some time. Witnesses for Purdue warned the F.C.C. that they "dare not become a body for suppression and repression."

In a shake-up of the Bureau of Air Commerce, foretold in these columns a
(Continued on page 295)

LOOKING AHEAD IN



(Photo—Philco Radio & Television Co., San Francisco.)
The modern service bench, with its test speaker, tube checker and set analyzer, is a model of efficiency. Above are shown 5 of them in a factory.

When Anning S. Prall, Chairman of the Federal Communications Commission, called to order the open forum on radio activities that unloosed the tongues of radio's foremost practitioners, one of the most important events in the history of radio was chronicled. As a direct result of the information made available at this conference, many new radio services of importance to every person in the radio business will soon be accorded by FCC the life-giving ichor of frequency assignments and other engineering grants so essential to their very existence and growth.

R. D. WASHBURNE

PART I

WORLD RADIO problems and plans affecting the "radio listening population" of more than *225,000,000, were searchingly analyzed, and either discarded or put on the table for further consideration (at the preliminary International Radio Conference at Bucharest in May, 1937, and the general Telecommunications Convention at Cairo in February, 1938), when more than 90 outstanding personalities, in the technical and business aspects of radio, this summer gave expert testimony before the Federal Communications Commission concerning the activities of over 70 of the foremost national and international organizations in the broadcasting, communications, and scientific radio fields.

The roundtable conference dealt mainly with new developments in connection with the frequencies made available in the range of 10 to 60,000 kc. (30,000 to 5 meters, respectively), in accordance with Article 7 incorporated in the General Radio Regulations adopted at the International Telecommunications Convention held at Madrid in 1932 (which superseded the Washington Convention in 1927).

* * *

Uncle Sam's \$1,000,000 spending spree on Army air stations, planned for 1937 under the watchful eye of the U. S. Signal Corps, will benefit the commercial airway systems, too. The program includes (1) setting up simultaneous radio beacons and weather broadcasting systems (OK'd by the Bureau of Air Commerce) at 18 fields; (2) installation of traffic control transmitters at 20 of the busiest Army airports; and, (3) replacement with high-frequency equipment, of existing low-frequency radio equipment at each of

the Army's 31 fields. The 1/2-million dollars worth of equipment the plan requires will make work for hundreds of radio men.

* * *

Before we take up specific instances of these new developments in the radio field, let us learn the background of legislation that limits and controls radio activities.

All general phases of operation in the broadcast band of 550 to 1,600 kc. will be open for informal discussion at hearings before the Broadcast Division of the FCC beginning October 5th. Broadcasters have been looking forward to this step, ever since President Roosevelt, last June, signed the Wheeler Bill repealing the quota system or Davis Equalization Amendment in 1928, to the Communications Act adopted in 1927 at the International Radiotelegraph Convention at Washington.

The newly-formed FCC, in 1927 found itself so hampered by lack of funds, despite the use of part of the finances of the Radio Division of the Department of Commerce, that a chaotic condition was rapidly developing as broadcast

stations in the larger cities strove to acquire the most desirable radio facilities. To aid the Federal Communications Commission in its work, Congress in the Fall of 1928 passed the Davis Amendment; as a yardstick, the Amendment adopted certain quota figures which allocated a value to stations of certain classes and power. It gave to each of 5 zones, 8 high-powered, cleared channel assignments; and to each of these zones, its share of regional and local stations, in accordance with the population. However, this arrangement resulted in overquota—States with a large area and sparse population were lacking in radio service. By reverting to the original Radio Act of 1927, through repeal by Congress last June of the 1928 Amendment, the zoning system was legally abandoned; it now remains only to carry out the provisions of the original Act, and it is for this purpose, in part, that an informal hearing beginning Oct. 5th, to which all broadcast interests have been invited, has been called by the Broadcast Division. Such changes as are brought about as a result of this hearing proba-

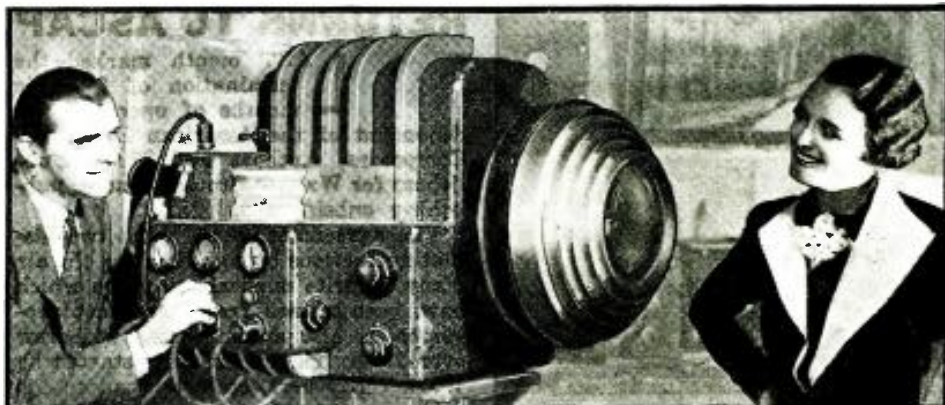

(Figure, per International Broadcasting Office, Berne, Switzerland.)

"Trapped by Television" is a Columbia picture in which Lyle Talbot co-starred with Mary Astor. Perhaps this television camera of the "future" is now out of date, in some television lab!

THE RADIO FIELD

Objectives of the FCC Open Forum

1. To determine the present and future needs of the various classes of service for frequencies above 30,000 kc. (10 meters, approx.), with a view toward ultimately allocating such frequencies to services;
2. To secure for the public and the Commission a deeper insight into the conflicting problems which confront the industry and the regulatory body in the application of the new frequencies to the service of the public;
3. To guide experimentation along more definite lines as may be justified from the evidence presented at the hearing;
4. To review present frequency allocations to services in the radio spectrum below 30,000 kc., and;
5. To assist the government in its preparation for the International Telecommunications Conference at Cairo in 1938.

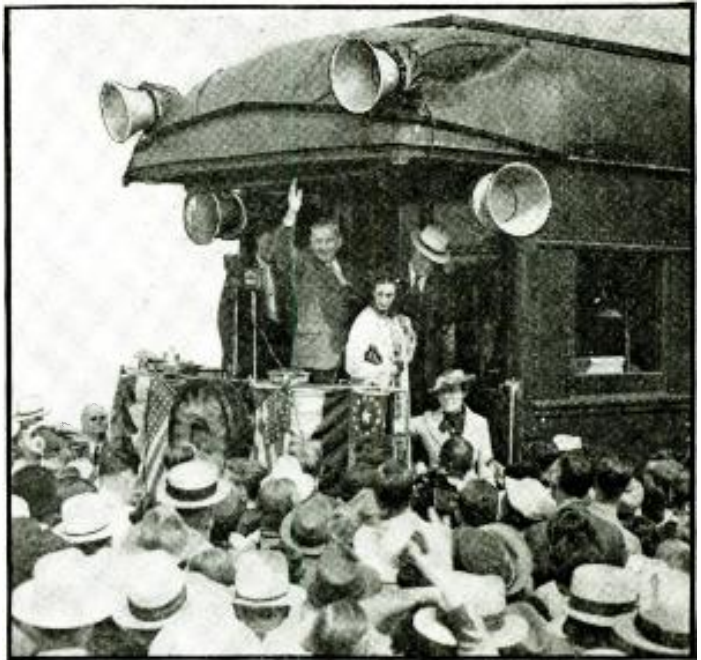

(Int'l. Photos)
Governor Landon rates P.A. an essential presidential campaign tool.

ably will occur gradually, so as not to disturb too greatly the existing economic set-up—that is, the design and construction of broadcast transmitting and receiving equipment.

By this diplomatic "squeeze play," as a result of the "speak now or forever after hold your peace" tenor of the forum, many laboratory developments of vital interest to the man who is looking into the possibilities of radio as a vocation were forced into the open.

* * *

Super-power station applications now number 6 that want to join the ranks of

WLW, Cincinnati, with 500,000 watts antenna power. These "follow the leader" stations are: WJZ, New York; KNX, Los Angeles; WHAS, Louisville; WGN, Chicago; WHO, Des Moines; and WJR, Detroit. If the FCC grants permission, this fall, for construction and operation of these "jumbo" stations, the service areas of the respective stations will be vastly improved. In simple terms, it means that the radio installation and repair business in these regions will be sufficient to put hundreds of small radio companies on Easy Street!

* * *

So much for the prologue. Let us now raise the stage curtain.

COMING EVENTS CAST THEIR SHADOWS

Said Commander T.A.M. Craven, Chief Engineer of FCC, "Radio is not only at the cross-roads in its comparatively brief development in the past 20 years, but it appears to be at the threshold of creating a new and important branch of the radio industry," as well.

The radio highway in the ether is badly congested from 10 to 20,000 kc.

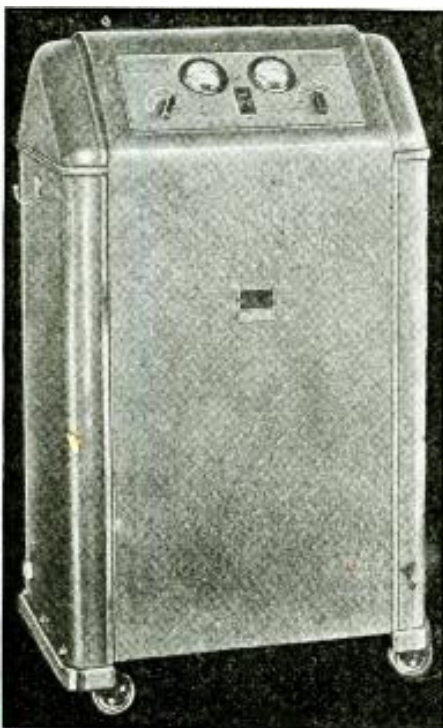

The interference tendency of certain diathermy equipment must be condoned on humanitarian grounds, but these units are rapidly being improved. Note the recent newspaper "ad." (Photo—Westinghouse)

SHORT WAVE
TREATMENTS

Produce Immediate Results in

STOMACH TROUBLES

and All Chronic Ailments

and rapidly becoming so between 20,000 and 30,000 kc. (about 10 meters). New services, such as *facsimile* (the electrical transmission and reproduction of fixed images) and *television* (the electrical transmission and reproduction of transient visual images), are voicing demands for both point-to-point and broadcast operation. Aviation is requiring more frequencies to afford better navigation in the air, and hence greater safety of life in the aeronautical industry.

Demands are increasing for marine and overseas public radio telephone service circuits.

The status of the frequency spectrum is about as follows: 10 kc. to 100 megacycles, useful; 100 to 200 mcs., still in the laboratory, but showing signs of having valuable application; 200 to 500 mcs., shows probabilities of future practical application; and, 500 to 10,000 mcs., highly problematical in its applicability. The vacuum tube today is useful up to about 100 mcs., but problems in the use of this device at the higher frequencies are being overcome very rapidly, and it seems logical to assume that we will have the vacuum tube with us, in some form or other, as an integral part of equipment operating at frequencies far beyond any we use today.

Although man-made interference (such as created by diathermy apparatus, X-ray machines, automobile ignition systems, and other industrial electrical apparatus) is an important obstacle to many services, it is probable that cooperation between all industry, engineers, scientists, and the government, will result in operation of most services that will be satisfactory to the general public. It is probable, though, that many radio men will secure good berths as "interference specialists" in all the large cities.

(Continued on page 310)

RADIO AND PUBLIC ADDRESS AT THE BERLIN OLYMPICS



ARRANGEMENTS for bringing to 225,000,000 worldwide radio listeners the "play by play" story of the events in the XI Olympiad held this year at Berlin, Germany, broke all records in their scope and extent.

As indicated by the background theme of this photo layout, and the photos

themselves, provisions for public address, ultra-short wave point-to-point radio communication, short- and long-wave broadcasting, and television were extensive. Broadcasting facilities also included spot transmissions over more than 35 broadcasting channels; and de-
(Continued on page 300)

RADIO PICTORIAL

Radio at Texas Exposition; Electronic piston-pin test; Russian television; Carrier telephone.



The P.A. system at the Texas Centennial Exposition was divided into 6 parts or loops, so that individual parts of the Exposition could be provided with different sound effects as desired. Sound emanated from special pylons which projected the sound in 4 directions, each tower covering a particular area of the grounds. The system cost over \$100,000!



Radio and Public Address worked together in aiding the effectiveness of the Texas Centennial Exposition at Dallas. The P.A. system consisted of 26 wide-range sound units combined with a large number of "singing towers" containing high- and low-frequency speakers. The studio (above) was also used for radio broadcasts.

Electronics has found useful application in automatically inspecting piston pins in the Ford Motor Co. plant. The piston pin enters the inspecting machine and is rotated under a phono pickup, so that variations in surface finish throw a relay. Hardness is indicated by a rebounding hammer which intercepts the light to a P.E. cell if hardness is correct.

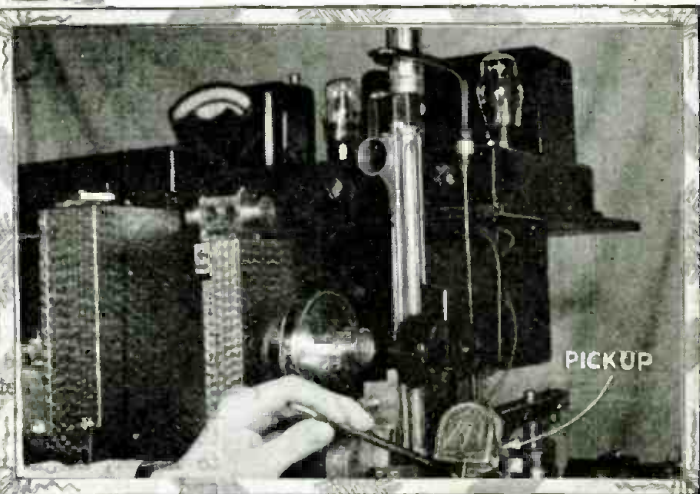
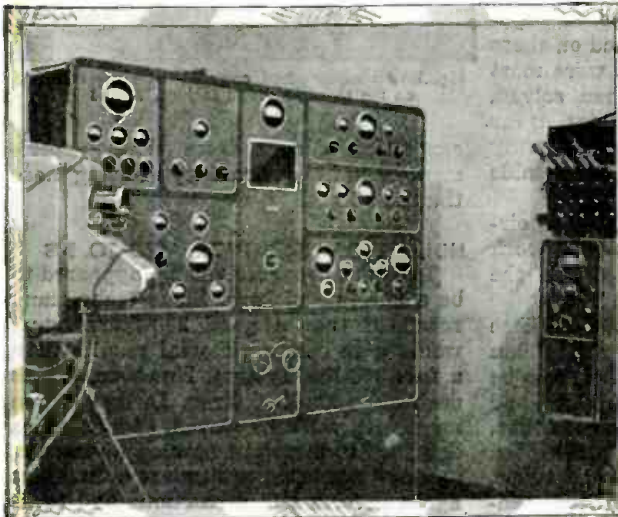

The first public cathode-ray television demonstrations of the Soviet Government were announced last month, with the introduction of a television transmitter utilizing a ray tube similar in some respects to the Zworykin Iconoscope. The system sends views of 70,000 picture elements. (SofFoto)

A new method of 2-way communication that uses the electric-light wires has just been placed on the market. By means of these units, 2 persons can walk into any building and by merely plugging into any 2 outlets, hold a 2-way conversation. Carrier wavelength is far above broadcast band.

Halbran Photo

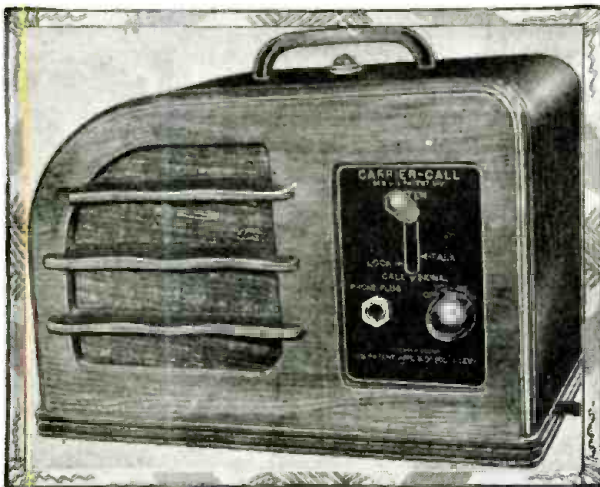

The novel communication device, shown at left and right, consists of a 4-tube unit with an electrodynamic speaker which acts as both microphone and reproducer. When used as the transmitter, a carrier is sent over the line, modulated by the dynamic "mike." As the receiver it acts just like a radio receiver. (It is claimed that it will not radiate.)

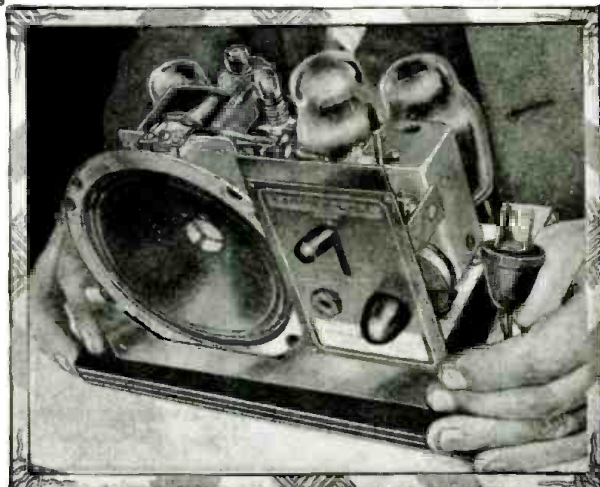

THE NEW PHILCO SYSTEM OF TELEVISION

The first detailed published description—exclusive to RADIO-CRAFT—of the new Philco system of television.

A. F. MURRAY

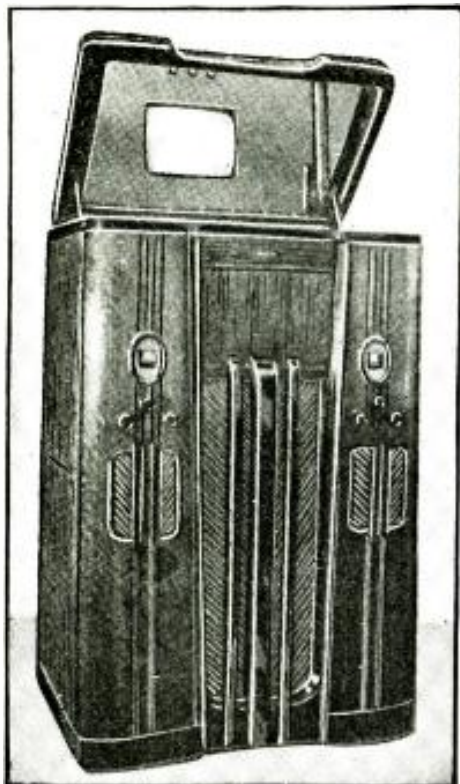

Fig. A. The appearance of the receiver console. The images are seen in a mirror in the lid. Note the comparatively few controls for sound and images.

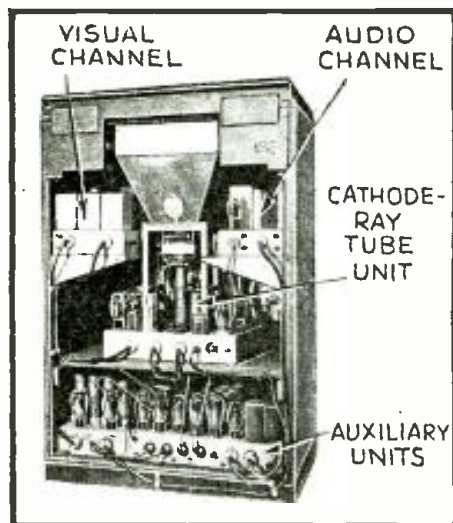

Fig. B. The rear view of the set chassis.

UNKNOWN to most of the television world Philco has been carrying on experimental television work for over 8 years! Rather than make premature announcements it had been deemed better to wait until an appropriate development stage was reached before describing the activities in this new branch of radio communication.

To secure a picture was not such a great task, it was the removal of all of the small but nevertheless conspicuous defects that was the real job. The engineering staff being familiar with the difficulties existing in the leading systems at that time, concentrated on these very problems, the nuts that were most difficult to crack. These, when solved, permitted the laying of a foundation for a television system which gives truly high-definition pictures of acceptable quality.

Hand-in-hand with the television circuit advances progressed research work in the vacuum tube laboratory on the special tubes used in the system.

Picture quality equal to that of home movies was, and still is, the goal. Such a requirement forced our engineers to be careful of small defects, distortions and the like, whether due to the camera tube, the picture tube or the system. This led to larger, brighter cathode-ray tubes, and camera tubes of improved sensitivity and detail. Cathode-ray projection tubes were built to explore the paths leading to larger pictures. One



Fig. E. An unretouched copy of the views received on the receiver shown in Figs. A and B.

conclusion drawn from these experiments was the desirability of using more than 240 lines.

NUMBER OF LINES INCREASED TO 345

The next progressive step appeared to be a 345-line picture. Some technicians reasoned that a good 240-line system would give better pictorial results than a fair 345-line system. However, it was decided to try 345 lines. In due course amplifiers were improved, special tubes designed to meet the new requirements, and new scanning equipment built. Once again defects and distortions had to be eliminated one by one.

Again a satisfactory image was obtained. (Continued on page 315)

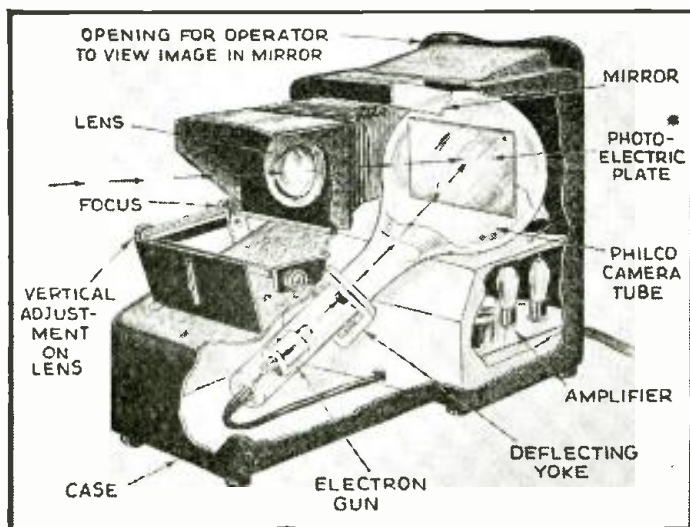

Fig. C. A phantom view of the special viewing camera.

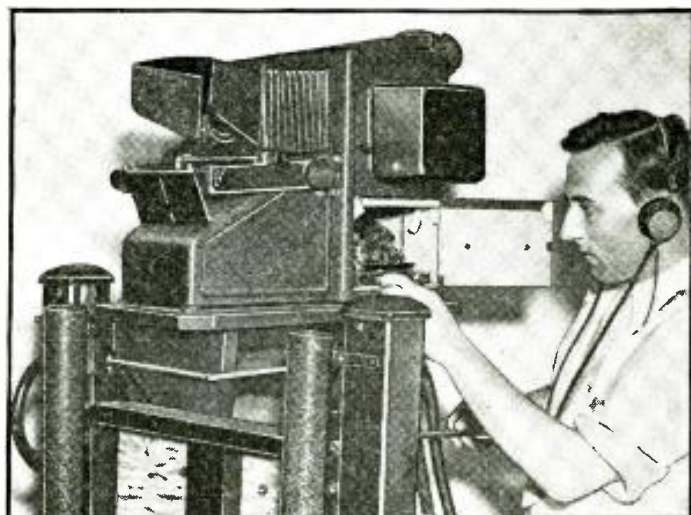

Fig. D. The appearance of the camera ready for operation.

NEWEST TUBES FOR THE RADIO INDUSTRY

The octal-base tubes are gradually encompassing the entire tube field, replacing existing types and supplying similar characteristics.

J. H. GREEN

OCTAL-BASE tubes took long strides, last month, in replacing existing types, even invading the heretofore untouched group of 2-V. battery tubes. Table I is a compilation of the comparative numbers of the new tubes, having octal bases, with the previously-available types having the same characteristics. In some of these cases, the previous tubes are glass types and in others they are metal tubes.

The 25-V. series of tubes is particularly well represented this month, as exemplified below:

25B5—Dynamic-Coupled Dual-Triode. This tube is equivalent in characteristics to the well-known 6B5, with the exception of the filament which is designed to operate at 25 V. Because of its filament, the tube is expected to replace the type 43 tube in many A.C.-D.C. sets, supplying triode class A output in place of the pentode output with its relatively high harmonic content.

It is interesting to note that the new tube, requiring no external bias, takes advantage of the full 110 V. of the "B" supply in A.C.-D.C. sets, thus supplying a maximum output of 2 W. with 9 per cent harmonic content, compared with only 0.9-W. from the 43 in a similar circuit.

25B5 Characteristics

Heater Voltage	Coated uni-potential cathode	
Current	25 A.C. or D.C.	0.3 A.
Class A Amplifier		
Output Plate (P ²)	110	180 max. V.
Input Plate (P ¹)	110	100+ V.
Control-Grid	0	0 V.
Plate Current (I ^{P2})	45	46 ma.
Plate Current (I ^{P1})	7	5.8 ma.
Amplification Factor	25	35
Plate Resistance	11,400	15,200 ohms
Mutual Conductance	2,200	2,300 mmhos
Load Resistance	2,000	4,000 ohms
Power Output	2.0	3.8 W.
Harmonic Distortion	9	9 per cent
Signal Volts For Rated Power	21	21 r.m.s.

25N6 — Dynamic - Coupled Dual-Triode. This tube has the same characteristics as the 25B5 described above,

the only difference being in the use of an octal base on this tube. The 25N6 tube can be used as a replacement for the 25A6, by simply shorting the cathode bias resistor in sets designed for the latter tube.

The manufacturer, Triad Mfg. Co., recommends that for best results, a diode-type detector be used before the 25B5 and 25N6. In experimental work, it was found that the 6Q7 supplied the optimum characteristics for use with these tubes.

25B6G—Pentode Power Amplifier.

This tube, also, is an improvement over the type 43. It is a glass tube, with octal base. It is a power pentode, known as the "uni-potential cathode" type, according to the manufacturer, Raytheon Production Corp. The output power of 1.75 W. is materially higher than the 0.9-W. supplied by the 43 with 95 V. applied to the plate and screen-grid, and a control-grid bias of -15 V., the plate current is 45 ma. and the screen-grid current is 4 ma. At maximum signal voltage the screen-grid current rises to 12 ma.

25B6G Characteristics

Voltage	25.0 V.
Current	0.3- A.
Class A Amplifier	
Plate Voltage	95 V.
No. 2 Grid (screen-grid) Voltage	95 V.
No. 1 Grid (control-grid) Voltage	-15 V.
Plate Current	45 ma.
Screen-grid Current*	4 ma.
Screen-grid Current**	12 ma.
Plate Resistance (subject to considerable variation)	
Load Resistance	2,000 ohms
Mutual Conductance	4,000 mmhos
Power Output	1.75 W.
(10 per cent distortion)	
*No signal	
**Maximum signal	

Added to these interesting new 25 V. tubes which are especially adaptable to A.C.-D.C. sets, are several new 6 V. tubes of the glass and metal types.

6J5G General Purpose Amplifier. This is a new glass tube having an octal (Continued on page 297)

The 25B5 tube except for its filament is the equivalent of the well known 6B5 direct-coupled triode output tube, which supplies the power sensitivity of a pentode without the harmonic content of the latter. The 25-V. filament makes the 25B5 a replacement for the 43 tube.

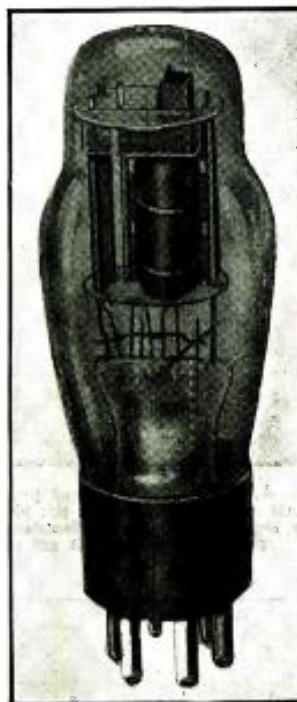

TABLE I
OCTAL-BASE GLASS TUBES AND EQUIVALENTS

Octal Glass Type	Equivalent Metal or Glass Type
1C7G	1C6
1D5G	1A4
1D7G	1A6
1E5G	1B4
1E7G	1F4
1F5G	1F4
1F7G	1F6
1H4G	30
1H6G	1B5 or 25S
1J6G	19 (exc'pt fl. curr. 240 ma.)
5V4G	5Z4
5X4G	5Z3
5Y3G	5Y3
5Y4G	80
5Z4MG	5Z4
6A8G	6A7
6B4G	6A3
6B6	6Q7
6C5G	6C5
6F5G	6F5
6F6G	42 or 6F6
6H6G	6H6
6J7G	77 or 6J7
6K6G	41 or 6F6
6K7G	78 or 6K7
6L6G	6L6
6L7G	6L7
6N6G	6B5 or 6N6
6N7G	6A6 or 6N7
6P7G	6F7 or 6P7
6Q7G	6B6 or 6Q7
6R7G	85 or 6R7
6X5G	84 or 6X5
6Z4G	84 or 6X5
25A6G	43 or 25A6
25Z6G	25Z5 or 25Z6

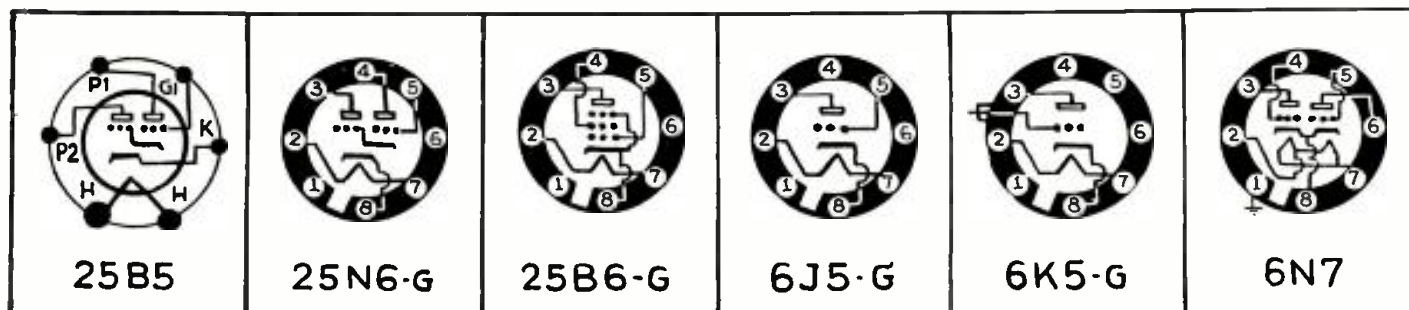

Fig. 1. The socket connections for the new tubes described on this page. The characteristics are given above, or references are given to other tubes with identical characteristics.

STREAMLINED MIKE IS ALSO A LOUDSPEAKER!

Essentially, this unit is a reversible loudspeaker that may be used as a microphone. It has been demonstrated to RADIO-CRAFT that the output of this unit as a mike is sufficient to operate a second one as a loudspeaker!

ANDREW HALBRAN



Fig. A. The neat appearance presented by the bullet mike is evident from this view. Because of the high efficiency, and directional characteristics "close talking" is not necessary.

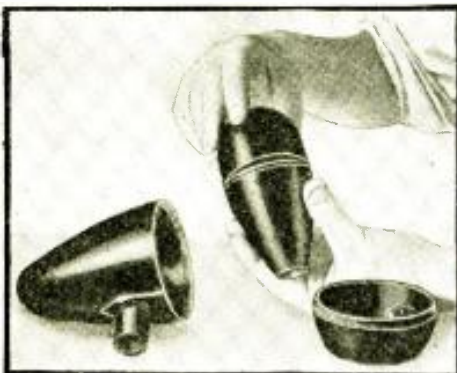

Fig. B. The bakelite construction used for the outer shell and deflector housing can be seen here. The "motor" unit is in the inner case.

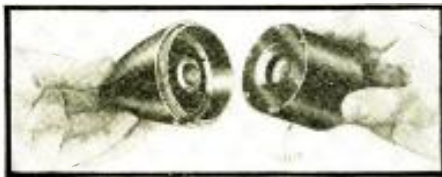

Fig. C. The actual unit nests into the bakelite case as shown above. The conical diaphragm of the mike can be seen in the right-hand part of the instrument.

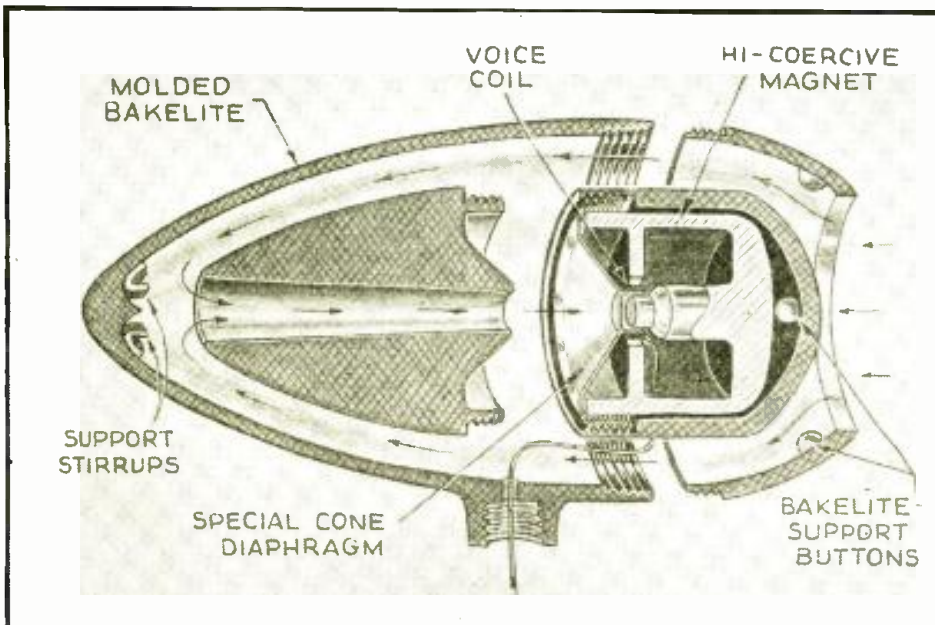

Fig. D. The parts and their method of assembly can be seen in this phantom view.

HERE IS a magnetodynamic microphone so sensitive it rivals and bids fair to exceed the sensitivity of a carbon microphone!—and yet requires no current supply to operate it! (See Fig. A.); furthermore, it may be made to function as a "transducer" (that is, both as transmitter or microphone, and as a reproducer or loudspeaker); see Fig. E!

The "secret" in this amazing new development in public-address equipment is a two-fold one: (1) a diminutive high-coercive magnet is used; and, (2) a tiny exponential trumpet effect is secured in the molded bakelite housing; see the cross-section illustration, Fig. D. Let us refer to the detailed illustrations of this new microphone, to find out more about it.

MECHANICAL DESCRIPTION

Referring to Fig. B, we see 2 bullet- or egg-shaped housings that nest one in the other; within the inner housing is contained the "motor" or microphone unit—one-half the inner housing is the actual dynamic unit, as shown in Fig. C.

Note the extreme compactness of this dynamic microphone unit. The exact relations of all the components of this microphone are clearly shown in Fig. D. Here we see that the path of the sound waves, which enter the large opening at one end of the outer housing, is along an outer chamber that gradually decreases in dimensions; at the end of this chamber the sound waves are deflected into a tapered, tubular chamber that runs through the center of a second bakelite molding to which the dynamic unit is threaded—the exact conformation of these tapered chambers is extremely important in securing the fidelity and exceptional sensitivity that characterize this new microphone. The sound waves then impinge on the small, specially-constructed conical diaphragm to the apex of which is fastened the voice coil. (To facilitate the assembly of this unit resilient buttons are provided as supports at one end of the unit; at the opposite end resilient stirrups are used.) This internal design of the microphone causes the voice frequency to travel over an area that is approximately twice the length of the housing, before it reaches the diaphragm of the dynamic unit. A small magnet of iron-alloy supplies a very intense magnetic field, that is cut by the moving voice coil.

(Continued on page 313)

FOR THE
FIRST TIME
IN ANY
RADIO
PUBLICATION

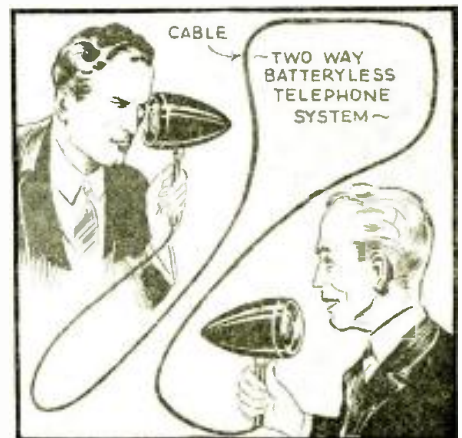

Fig. E. The high efficiency can be demonstrated by using 2 units as shown above.

RADIO-CRAFT receives hundreds of magazines from all parts of the world. Since the cost of subscribing to each of these would be prohibitive for most radio men, we have arranged with technical translators to prepare reviews for our readers.

INTERNATIONAL RADIO REVIEW

A FRENCH "BUTTON-TUNED" RECEIVER

IN THE latest issue of *L'Onde Electrique* (Paris) a group of new French radio sets was briefly described. One of these sets, shown in Fig. A., is unique in that it is tuned to any one of 20 stations by the simple expedient of pushing a button on the control panel! The set is equipped with *automatic frequency control*, similar to the American sets using automatic tuning (see the October 1936 issue of *Radio-Craft*).

No information was given as to how the buttons accomplish the rough adjustment in tuning in a station, but it is likely that a series of levers is used to turn the tuning condenser to the approximate point, the close tuning being done by the automatic frequency control. The magazine *L'Onde Electrique* expressed some doubt as to the practicability of "button tuned" sets in general.

A SELECTIVE CRYSTAL SET

THE MAGAZINE *Radio Tecnica* (Buenos Aires) recently ran an article which should interest radio experimenters and beginners. It contained the description of a really selective crystal set. The set was designed according to data discovered in connection with the development of tuners, and in fact uses a band tuner similar to those employed in some of the most modern tube receivers.

The circuit of this set is shown in Fig. 1. It will be noted that 2 coils and condensers are used, the coils being separated as far as possible and placed at right-angles to keep the coupling at a minimum. The coils are then coupled together by a small variable condenser which controls the selectivity of the set. A 2-gang condenser simplifies the tuning of the set—which has only 1 tuning control.

The coils are wound on cardboard tubes 2 ins. in dia. and 3 ins. long. Each coil is wound with 75 turns of No. 28

enamel-covered wire, and a tap is made at the 20th turn (55 turns from the ends of the coils which are connected to the ground binding post).

The values of other parts and the positions of the parts are shown in the diagram, and follow standard practice.

ENGLISH ACORN TUBES

A NEW midget tube similar to the "acorn" types made in the U. S. has just been perfected in England, according to a patent review in the latest issue of *Wireless World* (London).

As shown in Fig. 2, this new tube, however, is assembled without the usual "press" for sealing the leads, as connections are brought through widely-separated wires distributed around the outside of the glass shell. The elements are compressed into the smallest possible space by the use of a series of nesting rings on which the elements are mounted. Thus, the grids are flat screens mounted on insulated rings, while the cathode is a flat cup with a spiral wire filament in the bottom. By this method of nesting, the elements can be placed very close together, insuring efficient operation without the long, parallel leads which prevent ultra-high frequency operation in ordinary tubes.

AN ELECTRONOMETER TUBE

ACCORDING to a report in *L'Industrie Francaise Radio-Electrique* (Paris) recently, a new French tube has just been placed on the market for the measurement of minute currents.

This tube is used with a sensitive galvanometer in a circuit somewhat similar to the V.-T. voltmeters which have become so useful in high-frequency work. With one tube, a sensitivity of about 10^{-14} A. is possible, while with an amplifier following the electronometer tube, a sensitivity of 10^{-17} can be achieved.

This remarkable sensitivity to minute currents is made possible by reducing
(Continued on page 296)

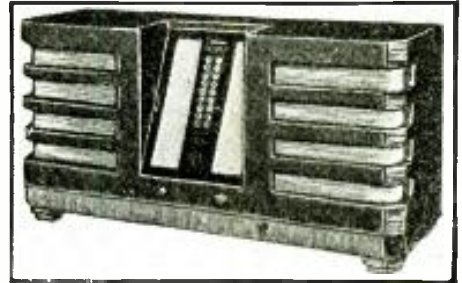

Fig. A. A French "button-tuned" receiver.

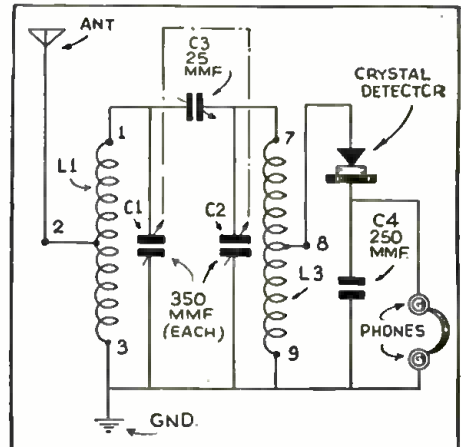

Fig. 1. A South American selective crystal set.

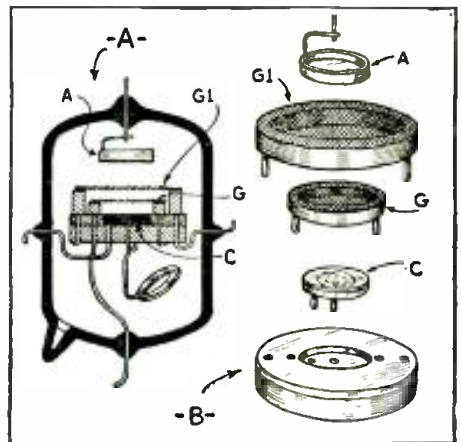

Fig. 2. The inside of the midget tube.

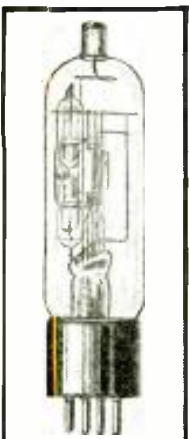

Fig. B. Electronometer

The electronometer, it will be remembered (from the physics class in school) is ordinarily a device consisting of a small folded piece of gold-leaf (gold foil) suspended in a glass jar with a contact on top, and is used for indicating the presence of tiny electric currents or charges. Since the power consumption is extremely small, the device can be used to detect the presence of small electrostatic charges, etc. This new tube is more sensitive than the gold-leaf type.

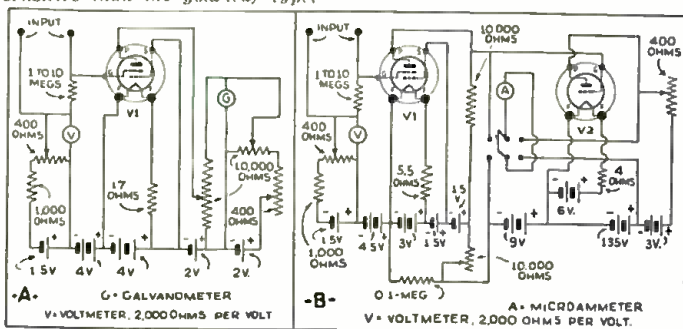

Fig. 3. Two circuits for the electronometer tube.



Fig. C. The appearance of the portable set.

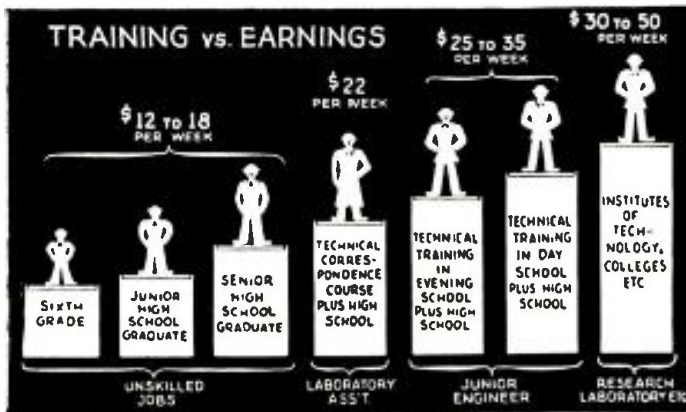

Fig. 1. The comparison of earnings in different groups.

A KEY TO RADIO AS A VOCATION

Have you considered your future in radio? What chance have you to succeed—what method of procedure will yield the best results? The answers are given below.

W. E. SCHRAGE

ATRACTED to some extent by the glamorous fame of the few big money makers in the broadcasting field, thousands of young people concentrate their hopes and thoughts upon the radio industry as the future realm of their vocational careers. A number of them dream of jobs as announcers or as artists in front of a nation-wide audience. However, it is not this group in which we are interested. Instead, our concern is with those who concentrate their thoughts upon the design or construction of transmitters and receivers, or upon research in one of the nation's leading laboratories—it is these whom we should like to guide through the labyrinth of the professional market, today.

A CHANCE FOR AMATEURS

An interesting feature about the American radio industry is the fact that a considerable number of the most successful men in this industry are former amateurs, and it seems that a consideration of radio as the future career for a radio amateur is not a bad idea, because it gives him a chance to utilize valuable experience acquired from his hobby.

It is certainly more sensible than to start a vocational trip in "terra incognita," i.e., to go into an industry where lack of fundamental knowledge of this industry makes it necessary to begin at the first step in the long stairway of experience collecting.

But this is not the only reason why a radio career seems to be a desirable one for the young radio amateur seeking a way to make good. The Grecian philosopher Plutarch said, some 2,000 years ago: "A man's felicity consists not in the outward and visible favors and blessings of fortune, but in the inward and unseen perfections and riches of the mind."

This statement, full of wisdom and knowledge of human nature, still hits the mark after all this time. However, and this is of great importance in today's world of dollars and cents—the radio industry is not only the realm for a young man who seeks "beauty of soul" but it provides at least as many chances as any other industry for the "right" man to make good.

But: "Who is the right man?" Not the one who likes to play around a little bit with radio, because all his friends do the same, but the one with inborn technical abilities, reinforced by proper training. Playboys, who go about the matter of radio somewhat similar to the housewife who lets the family starve if either the cookbook or the can opener gets lost, have little chance to make money, because creation and not reconstruction is the key to success.

This leads us to a discussion of the "nervus rerum," to the never expiring question of money. *How much money* can a young man with ability and deeper interest make in the radio field if he chooses it as his vocation? This question must be answered by means of another question: "What kind of training does this young man in question have?"

The importance of proper training for a successful career in radio's realm is shown quite impressively by Fig. 1. We see at the left side an unskilled laborer who "graduated" from the sixth grade of elementary school, and who would be better out of the radio industry since a person of his class has but little chance without additional training. He may eventually get a \$12- or \$14-a-week job on a factory assembly line, but he would do much better by going into the shipping department of the company, or somewhere else where unskilled labor is much better paid, than in the price-slashing atmosphere of the radio industry.

This does not mean that even such a "graduate" can't become the executive of a large business. It is, of course, quite difficult, but the history of American industry contains inspiring examples of hundreds of insufficiently educated men who did very well. It was, though, and still is, an infinitely torturous task to succeed in this way, and the few examples of brilliant careers are by far overbalanced by the hundreds, and even thousands who did not reach their aim. The history of our industry, however, seldom tells about their wasted struggles and starvation.

Successful careers of graduates of the 6th grade elementary school, on the other hand, are even possible today. Remember, too, that there is always plenty of room at the top for men with real ability. No one is born too late:

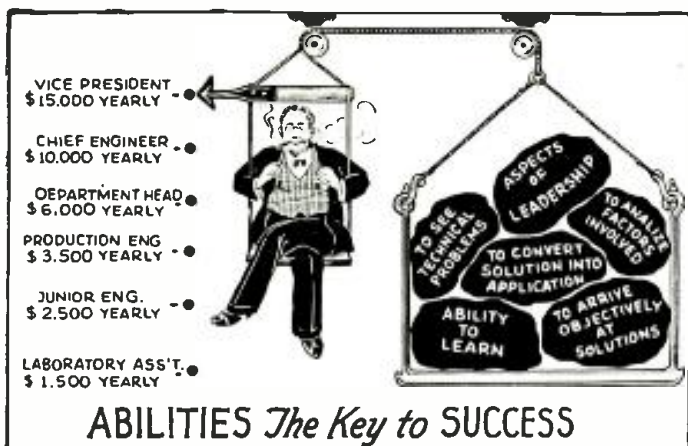

Fig. 2. The balance of education against income.

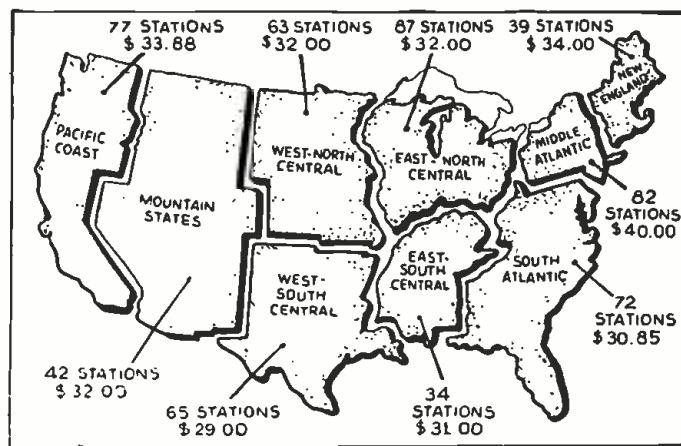

Fig. 3. National breakdown of technicians' average weekly income.

who is to go to fill the big jobs in the big companies when the big men who are filling them now are out of the picture?

But the chances are very poor for the man who trembles each time he is confronted with an application blank because he must bare the fact that he has but a limited school training.

I must also disappoint even those who graduated from *junior high school*, and in fact a great many who are graduated from *senior high school*, because they are also classified under "unskilled labor" when they must admit to being without additional training. There are, at present, thousands of high-school graduates who work on the assembly lines of American radio factories, and make not more than \$18 weekly, which is, according to the statistics of the Radio Manufacturers Association, the *average income* of workers of this industry!

HOW TO ENLARGE A \$18-PER-WEEK INCOME

Now let's take the case of a nice fellow who has not had the opportunity to attend the evening course of an accredited technical school. What is he going to do? There are many correspondence schools, and in addition there are many excellent public libraries all over the country. If he learns enough about radio technique by this method of vocational education eventually he may become a laboratory assistant, a job which is not only better paid, but one which also opens for him the road to the top, since if he has the chance to work in such a place, he may have an opportunity to show his real qualities and abilities. However it takes a man with a good brain and great ambition to succeed in this way.

VOCATIONAL EDUCATION MAKES THE ROAD SMOOTH

A more promising method in building the road to a successful career is by attending the evening or daytime courses in a technical school, or study courses of technical correspondence schools of good reputation (such as Coyne Electrical School, National Radio Institute, R. C. A. Institutes, Inc. and Sprayberry Academy of Radio.—*Editor*). Such a training entitles the man to a job as junior engineer which means about \$25 per week—and even more in a relatively short time, if the man in question has special qualities.

Of course, graduates from reputed schools of technology, as for example: M.I.T., etc., have the best chances. However, an education of this kind means quite a financial investment. In some, it involves a study consisting of 8 years in elementary school, 4 years in high school, and an additional 4 years in a college or an institute of technology. (As stated, in more detail, in the November, 1935, issue of *RADIO-CRAFT*.—*Editor*.) To just what extent this investment may be advisable in each specific case is difficult to decide, since a great many of the leading men in the American radio industry obtained their positions without such "intensive" training.

On the other hand, about 80 per cent of the rank and file of the great staff of the Bell Telephone Laboratories are graduates from universities, institutes of technology or similar institutions.

ABILITIES DETERMINE SUCCESS

Getting down to brass tacks, the success of men with or without academic training depends on other facts than just scholarly wisdom. *It depends on faculties which no one can learn, but which are inborn*, as for example the ability "to see problems"—that is, "to analyze the factors involved," "to arrive objectively and without prejudice at solutions"; and, last but not least—"to convert their ideas into designs of practical value" (see Fig. 2).

In addition to these abilities and qualities these men must have "aspects of leadership," and this is the kind of men the American industry is looking for. But as Mr. Samuel S. Board, the placement specialist states in a pamphlet, published by the American Society of Mechanical Engineers: "The demand for such men is greater than the supply"! And Mr. Board, an authority in this field, knows what he is talking about.

WOMEN IN THE RADIO INDUSTRY

Another point of interest in a discussion of chances for a career in the radio industry are the vocational opportunities for *women* in this professional line. One would think that

(Continued on page 298)

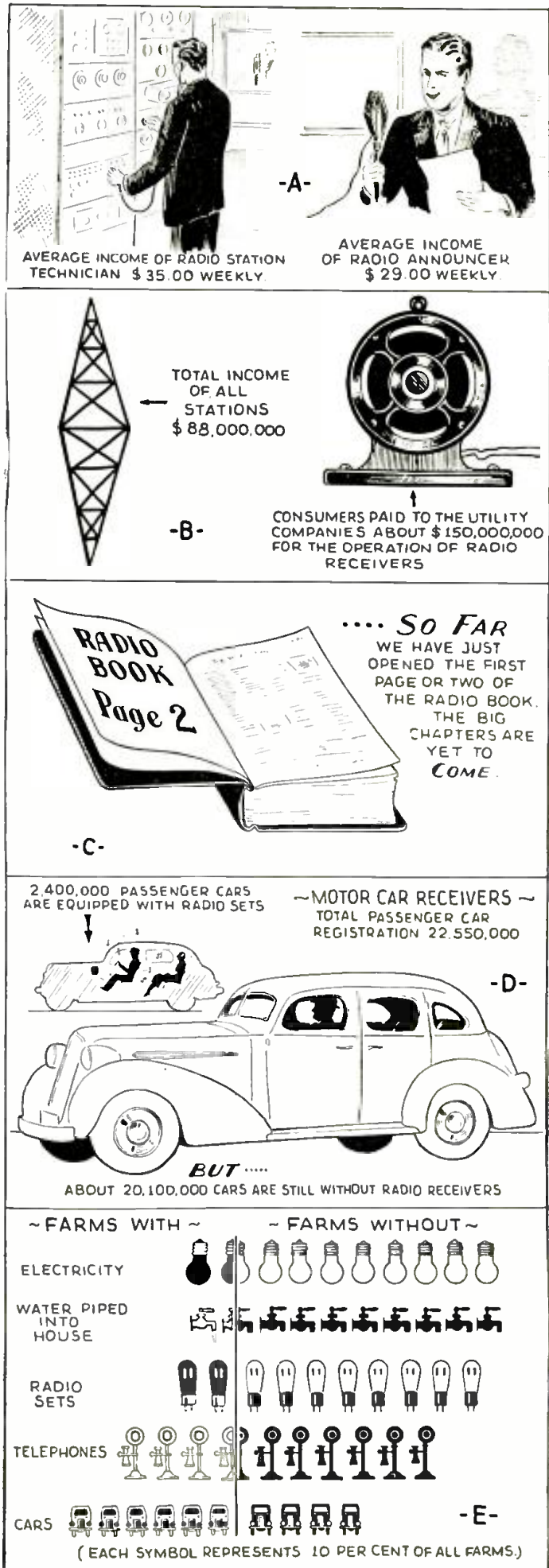

Fig. 4. Various factors involved in radio as a career.



Talking picture recording applies radio developments.

THE FAST-MOVING RADIO FIELD

A well known instructor, takes the reader through the labyrinth of radio development.

LOUIS L. CREDNER

RADIO TODAY is a fast-moving industry. During the comparatively short period of a decade, the rapid strides made in the development of radio have been nothing short of amazing. Progress has been achieved in improving the efficiency of operating, servicing, broadcasting, sound pictures, maintenance, electronics, research and allied activities. New ideas and new methods have been utilized to make radio indispensable in commerce, industry and the home. No other medium has been so largely responsible for the present popularity and widespread use of

tended to industrial applications through its photoelectric cell type. In addition the vacuum tube is now employed in such widely different fields as metallurgy, medicine, biology, music and other fields, to all of which it has contributed many definite advantages.

There is no denying the fact that before radio reaches its peak, other important and astounding inventions and applications relating to its use will be made. Indicative of what may be expected in this process of radio's evolution is the therapeutic branch of short waves now in its early stages of develop-

radio as the vacuum tube. Because of it, radio broadcasting and sound pictures have to a great extent attained their present state of development. Recently its use has been extended

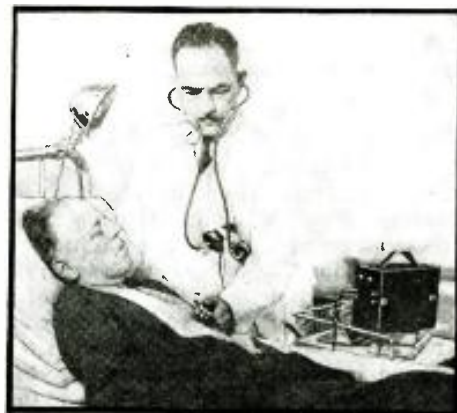

The electronic stethoscope—a new portable model.

ment. Already, experiments in short-wave fever therapy are being conducted by hospitals and in the laboratories of physicians and dentists. Today science has given the doctor the Inductotherm. This ingenious scientific device comes to the doctor's aid to help him destroy

(Continued on page 299)

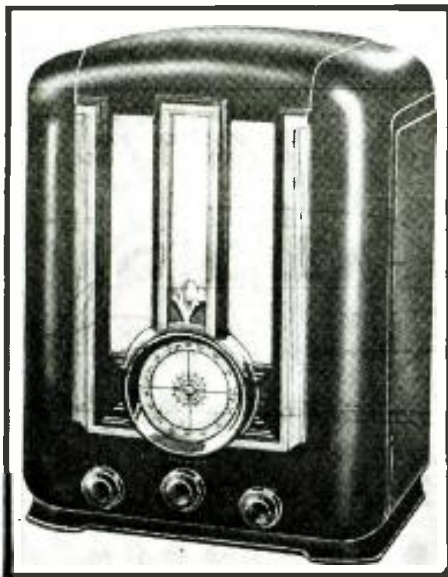

(Photo-Pilot Radio Corp.)
Molded radio cabinets attract attention.

THE BUSINESS OF "RADIO PLASTICS"

W. E. S. GRISWOLD, JR.

DON MASON

MERCHANDISERS and engineers of the radio industry spend unlimited time and energy searching for new developments and materials which will make better radio receivers.

One of the most important results of such research activity has been the introduction of "molded" products for radio cabinets and parts. Radio engineers have found that molded parts not only improve the tonal qualities of the instrument but also provide opportunities for simplifying methods of production. And the problem of merchandising takes on new interest because of the unlimited possibilities in design afforded by molded parts and cabinets.

In spite of the widespread popularity of molded materials in the radio industry, comparatively few people actually know what they are made of, how they are molded, and what advantages they have to offer. The story is indeed an interesting one.

PHENOLIC RESINS

Of the various types of molding resins
(Continued on page 301)

WE WILL endeavor to give you a picture of the development of radio and the part that molded materials have played in this development from the early days of "wireless" (radio telegraphy) and radio broadcasting.

Long before 1923 when the public began to be radio conscious, molded materials were aiding the commercial producers of radio's parent, "wireless" (radio) telegraphy. When commercial radio code apparatus was being installed on ships and on shore stations, molded and laminated insulation items were component parts of these sets. Panels were laminated phenolic and many insulating parts, dials, knobs and switches were made of molded phenolic compounds. In 1916 pioneer amateurs, in constructing their spark-type sets equipped with regulation telegraph keys and headphones, were also relying upon these materials.

But radio history records its first big steps forward during that period which first saw the advent of the vacuum tube,
(Continued on page 300)

Two internationally-known manufacturers of molded radio products tell you the history and latest status of this important branch of the radio industry. The importance of these phenolic molded and laminated materials is well-known to old-timers.

A SPECIAL A.F. AMPLIFIER FOR THE DX-ER

This high-gain amplifier with high- and low-frequency volume control has "automatic frequency gain," or "A.F.G."

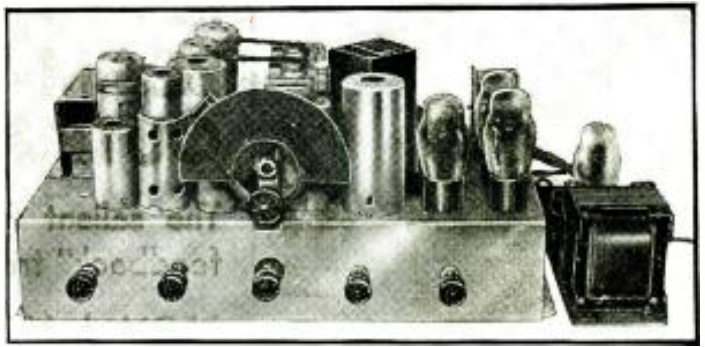

Fig. A. The appearance of the complete tuner and amplifier.

PERCY STEELMAN

HERE IS AN audio-frequency radio receiver "end" for the DX-er, which features 11 outstandingly important elements that relate directly to best performance in the reception of long-distance ("DX") programs. These features are listed in Table I.

It is known that the A.F. characteristic of a "DX" receiver can either aid or impair its efficiency for long-distance reception. Another fact which is often overlooked is that, in the great geographical area of this country, most broadcast and short-wave receivers must properly be regarded as DX receivers. The prevalence of dead or semi-dead spots, freak geographical channels wherein stations 1,000 or more miles distant overshadow locals, the directional effects of weather conditions, and the bugaboo of fading, are difficult and very real reasons for that statement.

The development of high fidelity has been a step forward in the art of broadcasting and its reception, and its use is to be desired whenever possible. Except

in the metropolitan shadow of the transmitters, high fidelity by way of intermediate-frequency band expansion is seriously curtailed. Outside of these areas, if the listener is to exercise the right of program selection, less than 10 kc. selectivity is usually necessary. To achieve realism of reproduction from a sharply-selective superheterodyne tuner, regardless of whether the selectivity (and therefore the fidelity) is variable or not, an A.F. system with a variable treble response is desirable. At the same time, the desirability of bass control has long been known, since it has been indirectly accomplished in all modern receivers by a variable treble cut-off!

NEW TYPE VARIABLE A.F. RESPONSE

Considering those somewhat opposing factors, the author has designed and built an A.F. amplifier which gives variable response on both ends of the audio-frequency range. It makes possible hitherto unknown enjoyment of DX music. It will put snap into a dull, flat tuner, and resonant boom into a reluc-

TABLE I
Features of the DX audio "end"

1. Continuous independent bass injection or attenuation.
2. Continuous independent treble injection or attenuation.
3. Separate volume controls feed bass and treble into the output, which is in turn controlled by a master volume control.
4. Real automatic tone control: i.e., automatic increase of treble response on the stronger signals, with quieter tuning and quieter fading.
5. Controllable elimination of objectionable roar while receiving certain stations.
6. Controllable elimination of squeals and chatter while receiving other stations.
7. Corrections for variations in frequency response as noted in the transmissions of various stations and programs.
8. An unusual flexibility in the matter of personal tone control.
9. Power output dependent only on output tubes and speaker used.
10. Excellent 3-stage amplification for mike, phonograph, or electrical musical instruments.
11. Economical and easy to build.

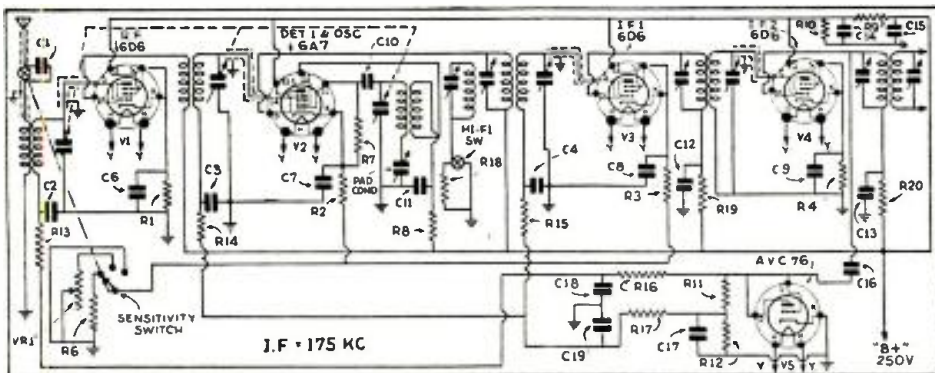

Fig. 1. The tuner circuit which is a high-gain device. Values are in List of Parts.

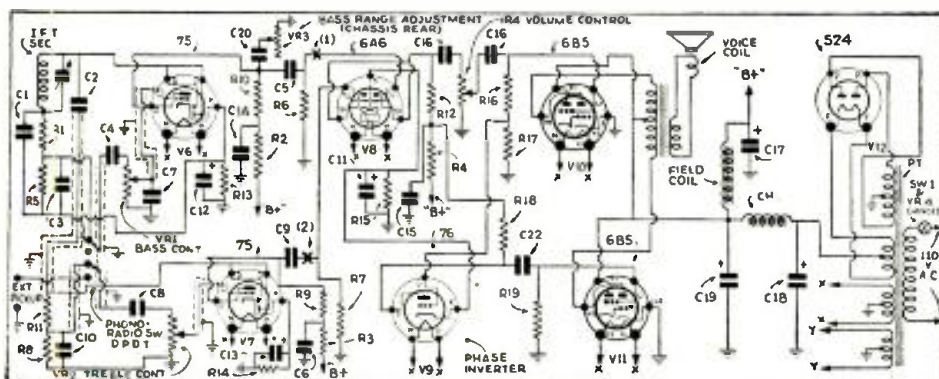

Fig. 2. The audio amplifier circuit. Note the treble and bass control systems.

tant speaker; or (and this is oftentimes more important), it will remove the snap or boom!

The superhet. tuner used with this amplifier was built to give reliable reception in a country dead-spot. It has little to recommend it beyond the fact that it is a "brute force" selector. It copes with a very high noise level, unusual amplitude swings of R.F. input voltage during fading, and a nightly condition during which stations 1,000 to 2,000 miles distant over-ride locals 30 miles away, seemingly bringing in all of the extraneous noises en route. It was aligned "right on the ball" and then stagger-tuned a very small amount. (See Fig. 1.) Consequently the electrical sound fed to the 2nd-detector is far from satisfactory. It is a distortion device, and an audio amplifier capable of complementary distortion is required to supplement it.

The A.F. amplifier, which is shown in schematic at Fig. 2 was built to get the utmost realism in the reproduction from this tuner.

To give definite, positive frequency discrimination in the high and low A.F. channels, 2 distinct detectors are used, and mixing is accomplished electronically. The circuits and parts are all

(Continued on page 302)

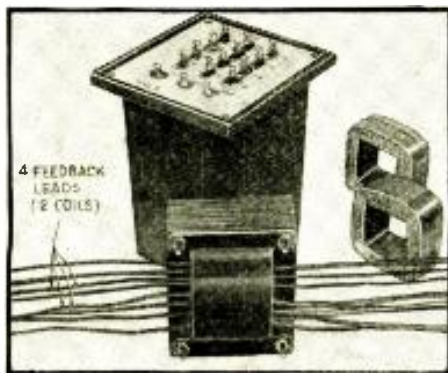

Fig. A. Complete transformer and component parts.

NEWEST DEVELOPMENTS IN BEAM-TUBE INPUT AND OUTPUT TRANSFORMERS

The salient factors involved in the design of "reverse feedback" transformers for use with the 6L6 power tubes.

LEON J. LITTMANN

IT HAS been pointed out that the 2nd-harmonic distortion present in the 6L6 tubes is very large and to obtain the rated low percentage of total-harmonic distortion it becomes prerequisite to employ these tubes with associated circuits which are designed to eliminate and to balance out this 2nd-harmonic distortion.

Up to this time all the efforts of the tube manufacturers were towards making the harmonic distortion as low as possible. According to their ratings, apparently the best that was obtained were tubes with a total harmonic distortion of 5 per cent. However, it is possible to obtain as little as 0.6-per cent harmonic distortion with the new type 6L6 tubes, if used in conjunction with the proper circuits. There are essentially 3 methods which were found to be most satisfactory.

The first method is to take part of the plate signal voltage and feed it directly into the control-grid return of the corresponding tubes.

Figure 1A shows the use of a resistor-

capacity network that can be used with any standard output transformer which has the proper impedances, provided that the input transformer has split

(Continued on page 311)

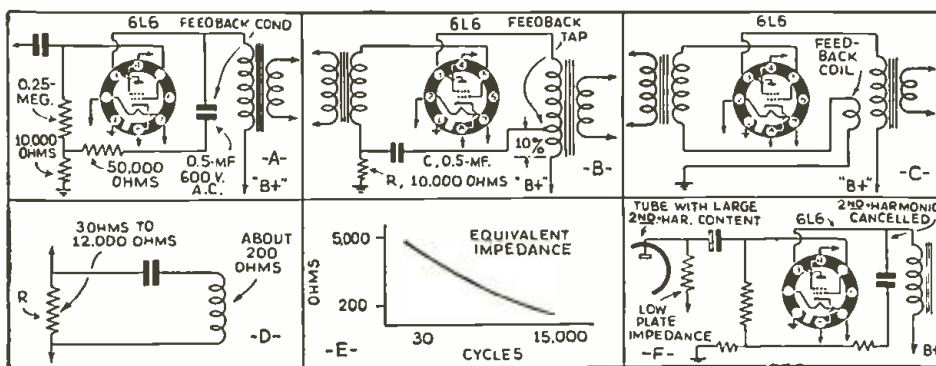

Fig. 1. Detail circuits showing the different methods of obtaining high output and low distortion, with 1 tube.



AN "ACORN"-TUBE BEAT-FREQUENCY OSCILLATOR

A new instrument for Service Men and technicians which has many applications in receiver and amplifier repair.

A NEW variable-frequency A.F. oscillator, operating on the beat-frequency principle, and weighing only 10 $\frac{3}{4}$ lbs., has just been placed on the market for service technicians and engineers. This oscillator, which is completely self-contained includes such features as a direct-reading dial and a center-tapped output transformer having impedances of 250, 500 and 5,000 ohms.

Applications of the new beat-frequency oscillator shown in Figs. A (heading illustration) and B, include (1) measuring receiver and audio-amplifier fidelity, (2) testing speakers and cabinets for howl, and (3) as a sweep frequency on an oscilloscope for checking unknown frequencies.

The operation of a beat-frequency A.F. oscillator is based on the "beat" or difference frequency produced when two R.F. oscillators are operated near the

same frequency and their outputs combined. By making one of these oscillators fixed in frequency and the other variable over a small range, the difference or beat frequency may be adjusted to any desired value, by shifting the variable oscillator.

In the oscillator, shown schematically in Fig. 1, the fixed-frequency oscillator consists of a 954 acorn-type tube, oper-

ated in an electron-coupled circuit at 350 kc. The variable-frequency oscillator is also a 954, operated in an electron-coupled circuit and operated over the frequency range from 335 kc. to 350 kc., the variation accomplished by a tuning condenser attached to the main dial.

The output of each oscillator stage is

(Continued on page 301)

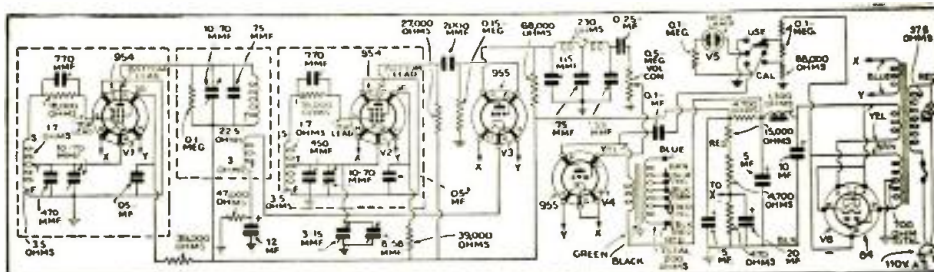

Fig. 1. The circuit of the complete beat oscillator including fixed and variable oscillators.

HOW TO MAKE AN OSCILLOSCOPE

The salient points in operating the oscilloscope, plus a number of useful references are given.

CHARLES SICURANZA PART IV

NOW THAT we have completed the construction of the oscilloscope, we are concerned, naturally, with the practical uses to which the instrument may be put. We shall endeavor to show how the instrument should be connected to the various pieces of apparatus under test, so that the builder may avoid misleading results and needless waste of time.

For an illuminating discussion of the many possible uses of the cathode-ray tube, the reader is referred to the excellent article in April, 1936, *Radio-Craft*, entitled, "The Versatile Cathode-Ray tube." Another article that describes some usual and unusual applications of the oscilloscope will be found in April, 1935, *Radio-Craft* entitled, "Fundamental facts about Cathode-Ray tubes." The second part of this article appeared in the May 1935 issue.

Last, but not least, the reader would do well to review the 6 articles by A. A. Ghirardi which appeared in consecutive issues of *Radio-Craft* from July, 1935, to December, 1935.

Most progressive Service Men own, or use, a test oscillator as part of their regular equipment. In order to obtain visual resonance curves of receivers, it is necessary to have both a test oscillator and some means of wobbling or shifting the peak frequency above and below the resonance point. The device may consist of a vernier condenser rotated at high speed by a small motor, or it may be of the inductive type which is also motor-driven. A third type, which makes use of the vibrator principle was described in *Radio-Craft* for June, 1936. All 3 types are used in conjunction with a test oscillator and the oscilloscope. A typical method of connecting the 3 units to a receiver is shown on page 474 of *Radio-Craft* for February, 1936. Using the same basic idea, it should be possible to wobble an audio-frequency oscillator to obtain visual audio response curves of each stage or overall response of a complete amplifier. (At the present writing, we are informed that such an instrument is under development.)

DISTORTION ANALYSIS

The subject of audio distortion analysis is of great importance. The designers of modern home receivers of the better type, make use of high-power, multi-tube audio amplifiers, which are more or less complex in structure. The average Service Man who is called upon to check audio distortion in any of these receivers, as a rule does not have any easy job on his hands. To begin with, the Service Man cannot be certain as to where distortion arises (in the more complex circuits) nor of what type of distortion he is confronted with. With the oscilloscope and a simple audio oscillator, it becomes a relatively simple matter to find the trouble, definitely and quickly.

We shall give one example of each of the 3 types of distortion which may be encountered in defective amplifiers. Figure 10A shows an example of *frequency distortion* which shows that the amplifier does not amplify certain frequencies as well as it does others. For this type of test, it is necessary to use an audio oscillator with a continuously-variable frequency output. The oscillator output *voltage* however, must not vary, as this would result in wavering of the waveform traced on the oscilloscope screen.

The second type of distortion is shown in Fig. 10B and is known as *amplitude or harmonic distortion*. In general, this

(Continued on page 304)

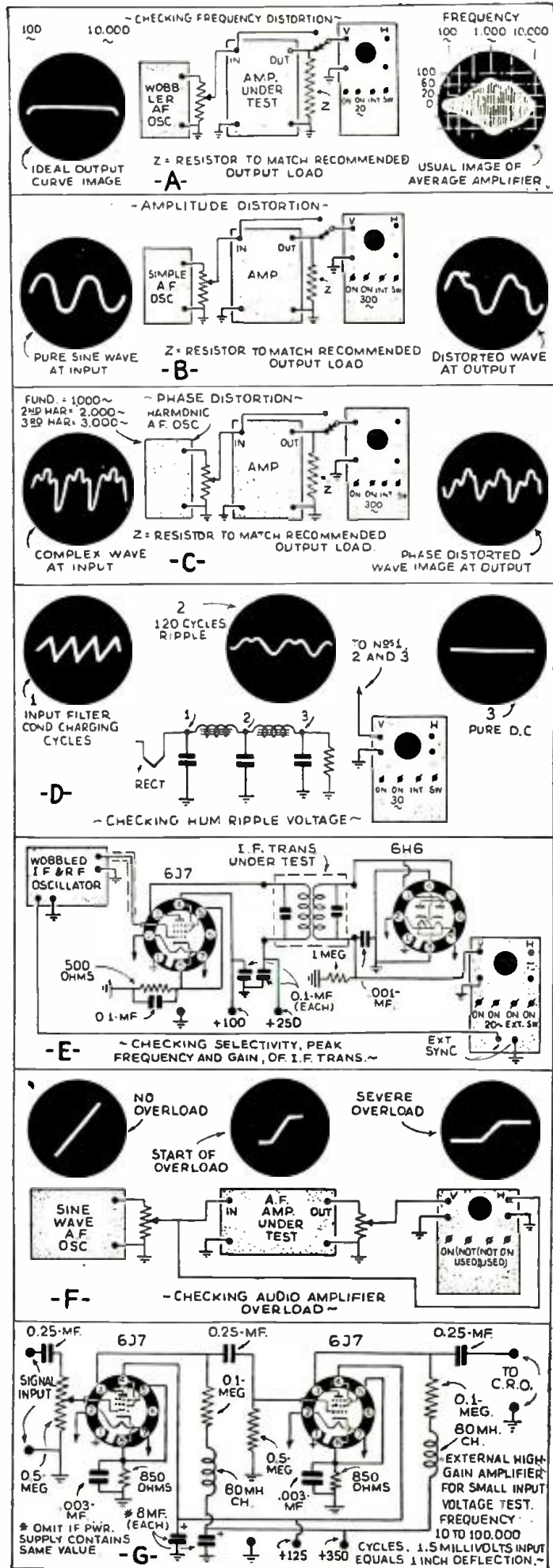

Fig. 10. Waveforms and circuit set-ups for using the device.



USING HEADPHONES IN SERVICE WORK

The author proposes several effective ways to isolate trouble with "headphone" testers.

PAUL A. BOTTORFF

AN ORDINARY radio headset possesses certain characteristics not frequently thought of. For example, the better grades have an absolute sensitivity of about 1/10-microampere, or better; consequently, even the trifling voltages induced on an antenna system alone, when rectified (as with a crystal detector) are capable of creating an audible signal. Thus a high degree of sensitivity compared to the cost is available. The following examples of the use of this simple piece of equipment are merely typical cases and are not all of the applications which might present themselves to the Service Man.

Use as an A.C. galvanometer or "null indicator." For many years bridges built to measure capacity, inductance, or resistance in alternating circuits have depended upon headsets as detectors of the balance point. Such bridges for use by Service Men (for the measurement of *capacity*, in particular) are now available at reasonable cost.

Condenser leakage tests. Probably the simplest and most

straightforward method of isolating a poor condenser is to put a charge on it with a battery (a single cell will do), then discharging this voltage through a phone. By an aural comparison of the volume of sound produced in the receivers after a period of time has elapsed since the charging, a general idea as to whether the insulation of the particular condenser has been punctured can be gained.

Testing continuity. By connecting a battery in series with the phones, and by means of test probes touched to the circuit in question in various places, the technician may immediately determine whether or not the circuit is open. This method of checking wiring of electrical equipment of all types is widely used in manufacturing plants.

Lining-up multi-stage sets. A number of the well-known manufacturers use the "headphone" system in aligning certain of the less "critical" sets and circuits. The process is to impress an A.F. modulated R.F. signal to the input terminals; by listening in headphones connected through a condenser (of perhaps 0.01-mf. capacity) to the output, it is possible to determine whether a particular adjustment makes the signal more or less audible.

Locating hum. To determine the source of hum in a set is sometimes baffling, but in general, it is either induced or is conducted into a circuit. If conducted, the probable source

(Continued on page 304)



A department devoted to members and those interested in the Official Radio Service Men's Association. For mutual benefit, contribute *your* kinks, gossip and notes of interest to Service Men, or others interested in servicing.

A MEMBER'S CONVENIENT TEST BENCH

RADIO-CRAFT, ORSMA Dept.:

As an ORSMA member (16,552) I believe the picture, Fig. A., of my service bench would be of interest to other members. In building it I wanted everything in 1 panel. As you will notice, at the top of the panel, the neon tube is recessed behind a glass window in a black box permitting me to see it without turning out the lights. Many other kinks are employed, and the panel affords facilities for all voltage and current tests, tube, resistance, and condenser tests, and standard resistances, and condensers are available by means of pin-jacks.

HARRY A. NORMAN,
Baltimore, Md.

sockets to mount the coupling condensers. Keep all the grid and plate leads short in the R.F. section. Be sure to mount the A.F. transformers and R.F. chokes under the tube shelf, using duolateral chokes, as shown in the illustrations. In the oscillator section, use a 30-mhy. duolateral choke mounted as close as possible to the plate terminal. The lower values of gridleak result in better tone.

It is really surprising how sensitive these machines can be when properly assembled and adjusted. The one I worked over would respond to a tin can several feet below ground!

I greatly enjoy Radio-Craft and believe it to be the best Service Man's magazine on the market.

E. H. DISNEY,
Lowry City, Mo.

(Continued on page 306)

"BRIEFCASE PORTABLE" (A CORRECTION)— TREASURE LOCATOR DATA

RADIO-CRAFT, ORSMA Dept.:

When I started building the "Talking Briefcase" receiver described in your September issue, I found an error in the diagram on page 137.

A connection is shown linking the lower ends of the 2 coils comprising the Ant. coupling transformer. This link would short out the 0.05-mf. bypass condenser, and also ground the 3 V. tap of the "C" battery through the 0.25-meg. decoupling resistor. No doubt most readers have noticed this error, but a correction notice might save some novice a lot of trouble. (The symptoms are reduced sensitivity, and circuit oscillation.) Reference to Fig. 1 will show which lead to remove.

Mr. Pugh's letter on page 163 under Readers' Dept. of same issue brings to my mind my experience with the "Treasure" Finder described in the August, 1934, issue of Radio-Craft. I rewired 1 of these machines after the constructors were unable to get satisfactory results. The following hints will insure proper performance. Mount the sockets in the receiver so that all the filament wiring is on one side and all the grid and plate wiring on the other with just enough space left between the

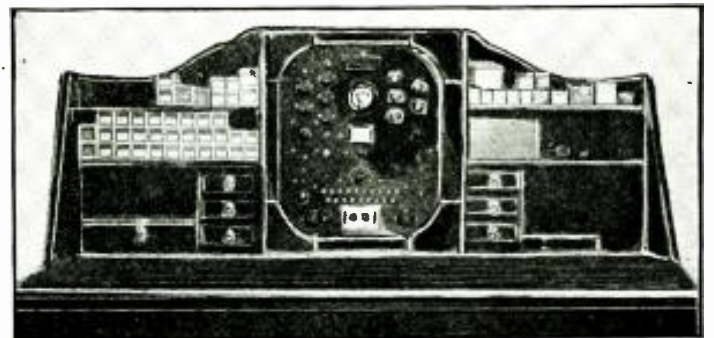

Fig. A. Well-designed and completely-equipped service bench of Mr. Norman.

ANALYSES of RADIO RECEIVER SYMPTOMS OPERATING NOTES

Philco Models 19 and 89. The chassis that is common to these sets reached the shop with the complaint that it was weak, insensitive, and there was no short-wave reception.

All tubes and voltages checked properly. By placing the antenna lead on the cap of V, reception was much improved. As may be seen in Fig. 1, the primary of the antenna coil is shunted with a 10,000-ohm resistor. The antenna lead was opened at X, and a continuity test showed that the primary coil was open. Replacing this coil restored the receiver to perfect condition.

E. H. Moss

Bosch 10, Twin-Speaker Model. One of these models came in with a very loud hum. Filter condenser C23 (Fig. 2A) was found open and replaced. The hum decreased materially but still seemed to be abnormal, especially with the tone control on the bass side. I was then informed by the owner that it had always performed that way. (The tone control had to be at the high level in order to listen comfortably to the set.)

Checking the circuit carefully I found the filtering system and the cable from the 2 speakers connected as in Fig. 2A. Compare this with Fig. 2B which is the correct diagram for this set. A little study will show that the filtering of Fig. 1A is very inefficient as compared with Fig. 2B. Changing 3 of the speaker leads to correspond with Fig. 2B entirely eliminated the hum. (Peculiarly enough, this set was originally wired that way, as proven by the lengths of the speaker leads!)

Crosley Fiver, 148, 167. The dual filter condenser of 6 mf., 300 V. and 8 mf., 25 V. in these sets will invariably open, short or develop a leak between sections.

When open, there will be uncontrollable oscillation; when shorted, a "dead" receiver; and when leaking, will result in distortion and low volume. For a permanent repair use a dual unit rated at 400 V. and 25 V., or higher if possible. (After all, there is only so much space.)

Crosley 173. Weak reception with all tube voltages OK can no doubt be traced to an open field coil (Jensen K3). The speaker field current is supplied independently by the 25Z5 rectifier.

Check the 8-mf., 25-V. electrolytic condenser connected from the first A.F. (type 78) suppressor-grid to tuning condenser frame. This will sometimes short, with a resulting slight decrease in volume.

Echophone S4. Very low volume accompanied by distortion, or no reception at all. Check the 1-meg. resistor (R2, Fig. 3) on the panel at rear and underneath the chassis. This resistor is in the 24A detector screen-grid lead and fails frequently. Replace with a 2- or 3-W.

Also check R6 and R8 (Fig. 3) for variations in value.

Fada KA. An annoying and persistent hum in these models, when all other remedies fail, may be cured by connecting a 1- or 2-mf. paper condenser from cathode of the 27 detector-amplifier tube to chassis.

Gubransen 13. No screen-grid voltage on the R.F. and I.F. tubes in this set is due to the failure of the screen-grid bypass condenser, a 0.3-mf. unit rated at 200 V. (C9, Fig. 4). This condenser is in a container with several other bypass units and has 2 (brown) leads from the ungrounded side. One lead goes to the R.F. screen-grid and the other to the I.F. screen-grid. When replacing this condenser, therefore, clip both brown leads from the condenser can and connect the 2 screen-grids together. A 0.25-mf. condenser rated at 400 V. will be entirely satisfactory to connect from screen-grid to ground.

Resistors R3 and R5 should be checked when condenser trouble of this nature has occurred as they may vary greatly from the values shown. (Even the volume control was burned out, on one receiver.)

Majestic 460 Chassis. Set Models 67, 68, 69, 196, 461, 463, 666, 776 & 886. Receiver "dead," with no voltage on the G-2A7-S modulator plate, indicates an open primary in the 1st I.F. transformer. Similarly, no voltage on the G-58-S (I.F. stage) plate shows an open primary in the 2nd I.F. transformer. (In the last 6 of these receivers repaired, I have had to replace 2 1st I.F. transformers and 4 2nd I.F. transformers.)

No screen-grid voltage on the R.F., osc.-mod., and I.F. stages is due to an open section of the Candohm voltage divider. This is the end section farthest from ground and should be 10,000 ohms.

High voltage throughout set is caused by an open in the next section measuring 9,000 ohms.

No voltage at all will usually prove to be a shorted 16-mf. electrolytic condenser (on top of chassis).

Philco 18. Intermittent reception. Faulty 0.05-mf. bypass condenser connected from antenna coil secondary to ground.

Philco 96. Several of these models have come to my attention with a whistle on every station and the report that several other Service Men had worked on them without success. Neither did I find anything wrong with the receivers in question but a good ground installation effectually silenced the whistles in each and every case.

One receiver in particular had been using a 5 ft. pipe driven in the ground, with a window lead to the set of not over 6 ft. in all from the pipe to radio set. This set (circuit) oscillated from one end of the dial to the other. A new ground clamp, window strip and new connections made not the slightest difference. A 55-foot wire to the nearest cold water pipe did the trick.

RCA Victor R-28-P or G.E. K-50-P. Intermittent reception in this set is quite often due to a defective condenser in the oscillator tuning circuit (C8, Fig. 5). This must be replaced with the exact size of 720-mmf.

The dual 4-4 mf. electrolytic condenser mounted under the chassis will often open or short. At the first sign of trouble replace both units as it will only be a short time until the other section goes.

RCA Radiola 82 or G.E. H-31. Intermittent reception for about the first 20 minutes of operation has been found in several of these receivers to be caused by a faulty condenser in the oscillator tuning system. (C2, Fig. 6) Moving this condenser slightly with a bakelite or rubber probing rod while the set is in operation will usually produce the cutting off. Do not replace with anything but the exact size, 745 mmf., and then readjust the low-frequency compensator, C1.

Silver Marshall J. No plate voltage on the R.F., mod., 1st I.F. and 2nd I.F., would seem to be a shorted 4-mf. electrolytic condenser connected from this plate supply to ground. Before removing this unit however, make a thorough check on the 1 mf. section of a triple metal-cased bypass block mounted near the I.F. sockets. This condenser, rated at only 300 V. usually is the offender.

Also check the 10,000-ohm, 3-W. carbon resistor connected between the plate supply and the screen-grids of the above stages. This will sometimes measure only 5,000 ohms.

Stewart Warner 102-A. When this model plays OK for 5 or 10 minutes, then gradually becomes choked and muffled with a corresponding reduction in volume it is usually evidence that the 47 amplifier circuit is going into oscillation. (This may be checked by watching the plate current, which will rise to almost double the normal reading.) To cure permanently, insert a 1-W. resistor of 7,000 or 8,000 ohms in series with the screen-grid lead; and if the 47 tube is the least bit weak, replace it.

A mechanical hum in one of these

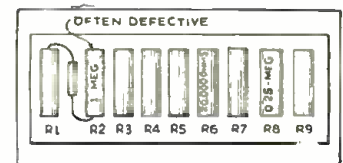

Fig. 3. Low volume and distortion in an Echophone Model S-4.

receivers was located after considerable trouble in the filter choke. The laminations are simply held together by a "shaped" cover, which should fit very tight. Squeezing the outer cover with a large pair of pliers will effect a cure.

The power transformer will hum badly at times and tightening the bolts does not seem to help much. If this trouble is encountered the bolts should be loosened or removed and the edges of the transformer core painted with heavy lacquer. Allow the lacquer to dry for a few minutes and then turn the bolts up as tightly as possible. Do not turn receiver on until the lacquer is absolutely dry.

Westinghouse WR-15 or RCA Victor R-11. Motorboating between stations only. Clean all tuning condenser rotor contacts and solder ground wire to each. Put in pigtail connection if possible.

Miscellaneous Notes. 1. Tunable Hum. In nearly all cases where one or more type 47 tubes are used in an amplifier, a loud hum on strong signals—especially with the tone control on the bass side—is due to insufficient filtering of the 47 screen-grid voltage supply.

2. Noisy Audio Transformers. To (Continued on page 311)

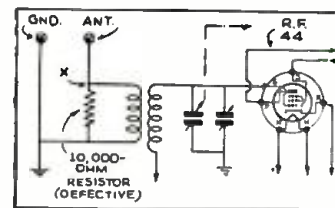

Fig. 1. Restoring sensitivity to a weak Philco Model 19 or 89.

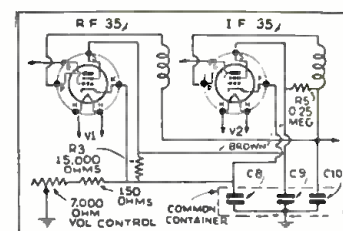

Fig. 4. Gubransen 13 trouble.

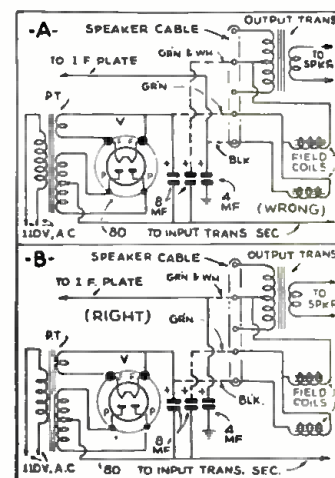

Fig. 2. Hum in Bosch model 10.

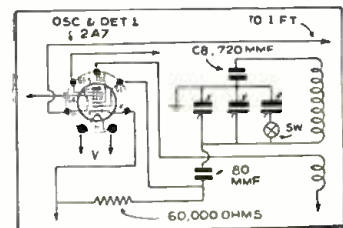

Fig. 5. Faulty series condenser.

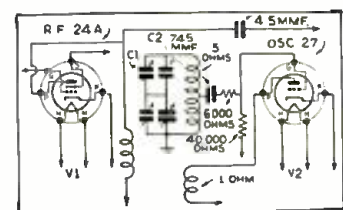

Fig. 6. Another faulty series unit.

THE LATEST RADIO EQUIPMENT



This set's novel appearance is achieved by using a "rear" speaker. (1179)

NOVEL RECEIVER DESIGN (1179)

(RCA Mfg. Co., Inc.)

THE SPEAKER outlet of this receiver is at the rear, as illustrated by the mirror. The circuit used is a 5-tube superheterodyne, covering a range of 540 to 6,500 kc. in 2 bands. The output is 0.9-W. The airplane dial has a 6-to-1 ratio with a band indicator. An antenna wavetrap and iron-core I.F. transformers are used. The cabinet is of novel design and is highly finished.

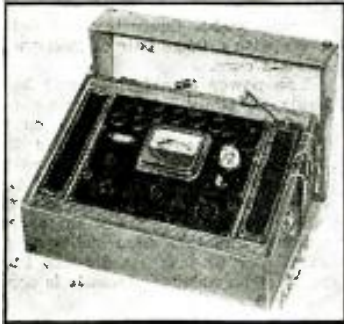

This new power output tube tester uses operating voltages. (1180)

POWER OUTPUT TUBE TESTER (1180)

(Triplet Electrical Inst. Co.)

THE EQUIVALENT of 9 separate units is contained in 1 case in this instrument. Tubes are tested by working them under approximately the conditions which they meet in the receiver. Any type metal or glass tube may be completely tested for worth and shorts. The apparatus also contains provision for testing all types of condensers, and may be used as a D.C. milliammeter, an A.C. or D.C. voltmeter, ohmmeter, or decibel meter.



Semi-portable 35 mm. projector. (1181)

SEMI-PORTABLE 35-MM. PROJECTOR (1181)

THE SAME quality of picture and sound as available in the largest theatres may now be had for school auditoriums, churches, etc. All the refinements to be had on the largest machines are offered in this equipment. Both variable-area and variable-density sound film may be used. Although the projector was designed for arc lamp projection, any Mazda-type lamp may also be used. Standard exciter lamps and photo-cells are employed.

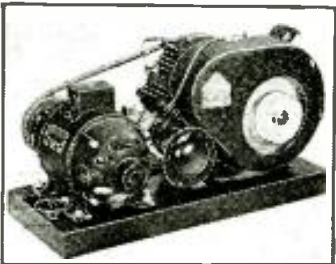

110 V. A.C. and 6 V. D.C., on tap. (1182)

GAS-ELECTRIC PLANT (1182)

A FULL-size A.C. power plant of 300-W. output at 110 V. is now available at a very low price. It will operate any 110-V., 60-cycle A.C. equipment, including radio sets. In addition, there is a 7½-V. direct-current winding which may be used to charge 6-V. storage batteries or to run any 6-V. appliance using less than 50 W. A switch cuts out this winding when not in use.

2-WAY 10-METER POLICE RADIO STATION (1183)

DESIGNED for the smaller communities which wish to install 2-way police car communication, this crystal-controlled outfit operates



A 10-meter 2-way police set. (1183)

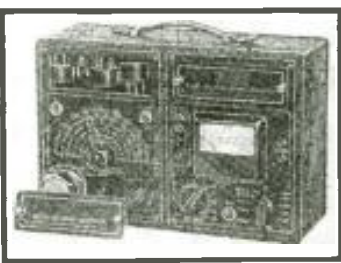

This combination tester is one of the first in a new series. (1184)

directly from the 110 V. A.C. lines. The receiver is of the superheterodyne type. Operation is on the band between 30 and 42 mc., and the quality of transmission is very good. The carrier power of the transmitter is 5 W. The receiver also uses crystal control for maximum stability.

COMBINATION TESTER (1184)

(Readrite Meter Works)

A DIRECT-reading signal generator and a multimeter are combined in this new "Ranger-Examiner" instrument. Both A.C. and D.C. volts may be measured from 0 to 1,000 V. in 5 ranges, and D.C. values from 0 to 250 ma. in 4 ranges. Ohms up to 0.25-meg. may be measured with provision for connection of external batteries for higher ranges. A reverse-scale low range of 0 to 300 ohms is also provided. The oscillator covers from 100 to 18,000 kc. in 5 ranges, and has individually-calibrated coils with built-in trimmers.

TRIPLE-SEALED CONDENSERS (1185)

(Tobe Deutschmann Corp.)

PRIMARILY designed for use in damp and humid climates, these condensers are triple protected. The condenser unit itself is first hermetically sealed, then placed in a tube and resealed. An outer tube is then slipped over and another seal given. All standard sizes are available.

UNIVERSAL TEST SPEAKER (1186)

ELECTRICAL characteristics of 95 per cent of all speakers used in home or car receivers may be perfectly duplicated by this unit. The replacement field coil consists of a high-inductance choke with 9 resistance values from 300 to 10,000 ohms, and taps at 300 and 2,500 ohms. The universal output transformer matches the speaker to any single, parallel, push-pull, class A, AB, or B output stage. Since the speaker is of the permanent-magnet dynamic type, it may be used to replace the original of any battery receiver. A socket is provided to enable the Service Man to quickly connect the speaker to sets which have plug-in speakers. The case is of steel finished in brown, with the escutcheons etched on aluminum.

COMBINED PHOTO-CELL & EXCITER UNIT (1187)

A COMPLETE photo-cell circuit is contained in the case illustrated. The cover is fitted with a lens

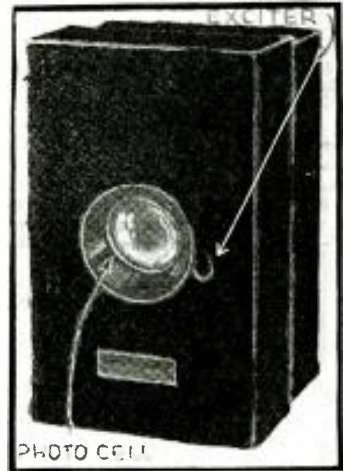

The exciter lamp and photo-cell are combined in this unit. (1187)

which focuses light on any remote mirror, and from thence to the cell within, for operation of a sensitive relay. The unit shown will operate its relay with an illumination of 1.5 foot-candles. It will operate about 10 to 15 times per second. The relay will carry 2 A. at 115 V. A.C.

"CAMPAIGN"-TYPE MOBILE SOUND SYSTEM (1188)

(Allied Radio Corp.)

HIGH POWER of 20 W. and high efficiency are assured with this outfit. The amplifier with its dynamotor, and all mixing and other controls are contained in a steel case, which also carries the built-in phonograph. The double-button carbon microphone has 12 ft. of cord, while the two 12-in. speakers each have 10 ft. of cord and polarized plugs. The amplifier circuit contains 3 stages.

ALNICO-MAGNET VELOCITY MICROPHONE (1189)

(Supreme Sound Labs.)

ALNICO magnets and a new magnetic circuit are incorporated in this unit. The dural ribbon is suspended in a shock-proof frame, and this combined with the shock-proof mounting of the entire microphone allows it to be moved without damage or noise. The transformer is shielded in such a way that hum is eliminated. It is impervious to moisture, in fact it may even be used in the rain without injury!



Condensers in all standard capacities. A "triple-sealing" process protects this newest condenser sufficiently for use in humid climates. (1185)

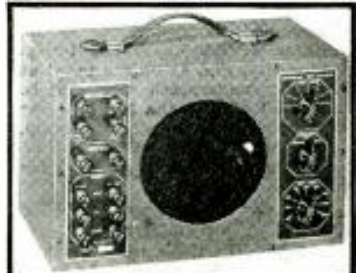

A universal test speaker. (1186)

Name and address of any manufacturer will be sent on receipt of a self-addressed, stamped envelope. Kindly give (number) in above description of device.



A 20-W., "beam"-type "campaign" sound system. (1188)



Alnico - magnet velocity microphone. (1189)



A "beam" 32-W. volume-expander portable amplifier. (1190)

BEAM POWER PORTABLE AMPLIFIER HAS VOLUME EXPANDER (1190)

(Amplifier Co. of America)

THE 32-W. output of this amplifier contains less than 2 per cent harmonics. The gain of 133 db. is sufficient to enable use of any type of microphone, as well as any type of phono. pickup. The circuit uses 10 tubes and features such advanced developments as compensated volume controls, automatic audio volume control, volume expansion, and high- and low-frequency tone controls. The field current for the two 12-in. speakers is supplied by the amplifier chassis. The entire system is housed in a case 21 x 19 x 12 ins. deep. The output of the system is sufficient to adequately cover 20,000 sq. ft. outdoors, or 18,000 people indoors.

NEW DYNAMIC SPEAKER (1191)

ALL UNITS of this new series are designed around a new and novel voice-coil support. This permits free longitudinal movement of the cone yet enables accurate centering of the voice coil so that a much narrower air gap may be used. The field coils may be changed or replaced without disturbing the pole-piece clearance.

A COMBINED MIXER AND PREAMPLIFIER (1192)

OBsolete power amplifiers designed for a single channel and carbon mikes may be brought up to date by use of this equipment. It makes possible the mixing of any 2 inputs, whether they are high gain or not. The single-ended amplifier gain on mike jacks is 65 db. and that on the phono. jack is 30 db. The self-contained power supply is exceptionally well filtered and shielded so that the output is humless. Output impedances are 200 and 500 ohms, while input is designed for high-impedance equipment.

COMPACT AIR-DIELECTRIC TRIMMERS (1193)

(Meissner Mfg. Co.)

TWO TYPES of the new air-dielectric trimmers are shown in contrast with an ordinary attachment plug, to show the size. The small size ("B"—1 to 12 mmf.) is intended for R.F. trimming work, while the large unit ("A"—50 to 100 mmf.) is used in I.F. transformers.



Useful for diathermy units. (1196)

Adjustment is made by means of the screw on the end. Ten turns of the screw are required for the full capacity change, and the variation is substantially linear. The movable electrode acts as a piston, sliding in and out of the fixed electrode and thus varying capacity.

20W. SOUND TRUCK AMPLIFIER (1194)

(Radolek Co.)

OPERATION of this amplifier is possible from either 6 V. D.C. or 115 V. A.C. The 6 tubes, used in a 4-stage circuit, provide a gain of 115 db. The frequency curve is said to be flat from 40 to 9,000 cycles within 1 db. All accessories are connected by means of plugs. Input circuits are provided for either crystal or double-button carbon microphone, and radio or phono., with mixing controls for fading either. The controls may be operated remotely from the steering column, if so desired.

A 12-TUBE 7 TO 2,100 METER RECEIVER (1195)

TWELVE tubes are used in this modern receiver which covers a range of from 7 to 2,100 meters, in 5 bands. The beam power output tubes provide an output of 20 W. of very high quality. All parts are impregnated for use in any climate, and air trimmers are used. Besides the 2-speed tuning dial there are tone control, compensated volume control, sensitivity control, variable selectivity, and a cathode-ray indicator to aid tuning. The chassis is used in all types of cabinets, and with speakers from 8 ins. to 15 ins. in dia.

HIGH-FREQUENCY CONDENSER (1196)

DESIGNED to offer the highest possible efficiency in high-frequency work, this new unit is especially adaptable to ultra-short wave transmitting, and to therapy work, at frequencies of the order of 30 megacycles and upward. The condenser shown has a maximum capacity of 28 mmf. per section and a 4,000-V. peak flash-over rating. Isolantite insulation is used and the plates are buffed and polished.

PORTABLE "DEMONSTRATOR" ANTENNA (1197)

(Philco Radio & Television Corp.)

SERVICE MEN who find it difficult to demonstrate new receivers in locations where the erection of a temporary antenna offers considerable difficulties, such as in large apartment houses, will welcome this easily and quickly-erected collapsible antenna. It can be put up in a minute or so and is said to give fine results on any band. It folds up into a compact weatherproof case.

DE LUXE PROJECTOR (1198)

RELIABILITY of performance is stressed in this apparatus. It features such refinements as a Geneva movement for shifting film, and a double exciter socket so designed that if a bulb burns out during a show, a simple shift of the bracket immediately brings the extra bulb into place and in focus. The whole design is so engineered that delays in performance will be held to an absolute minimum, just as they are in professional theatre work.

ANALYZER PANEL (1199)

(Radio City Products Co.)

WHEN used with a suitable multi-meter, this analyzer unit provides the user with a comprehensive free point, free reference system trouble finder. Metering at all socket terminals is provided, for current, voltage, resistance and capacity measurements. Tubes may be tested from the receiver chassis. Standard RMA numbering is used throughout, and future developments are provided for, since a spare wire is furnished in the cable, together with a spare terminal on the panel. The depth of 1 5/8 ins. allows the unit to be mounted in the cover of many meter cases.

6,000-V. "DYKANOL" CONDENSER (1200)

(Cornell-Dubilier Corp.)

A SPECIAL dielectric called Dykanol "A", which remains stable under all temperature conditions, is used in this condenser. The units are made in all standard capacities and ranges up to 6,000 V. They are amazingly compact, the 1 mf. size being only 2 1/4 ins. high. These units are ideal for transmitters and the higher power P.A. apparatus.

PORTABLE SPEECH AMPLIFIER (1201)

A 4-POSITION mike mixer and a 3-stage A.F. amplifier is included in this unit. It is designed to meet the needs of remote pick-up work of all types, and as such is housed in a case fitted with handles and removable cover. All necessary equipment is included, among which is a volume indicator, mike current meter, provision to read current of each mike button separately, constant-impedance T-type faders, etc.

CABLE-TYPE TRANSFORMER (1202)

(Amperite Corp.)

LOW-IMPEDANCE microphones may be worked into high-impedance amplifiers by the use of this compact transformer. The cable of the low-impedance microphone may

(Continued on page 307)



Interchangeable-field speaker. (1191)



A mixing preamplifier. (1192)

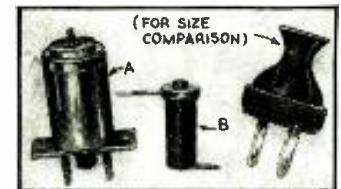

Air-dielectric trimmers. (1193)



A sound-truck amplifier. (1194)

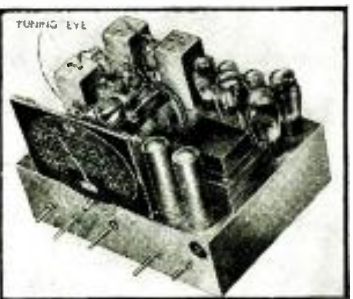

A 7- to 2,100-meter 12-tube. (1195)



Fig. A. The appearance of the 2-tube set.

THIS SIMPLE, inexpensive and highly efficient all-wave receiver has been designed to meet the needs of the radio experimenter of rather limited means. The design of the unit is such as to use only those parts which are essential to proper operation. No frills or fancy gadgets are used as they would only increase the cost, while contributing but little to the performance. The entire receiver may be made for a cost of approximately \$3. Constructed

BUILD THIS BEGINNER'S 2-TUBE A.C.-D.C. RECEIVER

This easily-built little set is an "all-wave" job—range, 10 to 550 meters. Try your hand at building it!

GUY STOKELY

so as to occupy a minimum of space this model measures only 4 x 5 x 2½ ins. and has a total weight of only 4 lbs. Its low cost and small dimensions make it an ideal set for the fan who wishes a small portable receiver to carry around on various outings and trips.

No batteries whatever are required, operation being entirely from the 105 to 130 V. A.C. or D.C. house current. By using the highly-efficient plug-in type coils this receiver can readily cover the entire wave-length range of from 10 to 600 meters. In this range is included a host of amateur code and voice transmitting stations, foreign and domestic short-wave broadcast stations, aeroplane and ship transmissions, police calls and regular broad-

cast band programs. Operated in an intelligent manner, even the inexperienced radio beginner should be able to pick up many of these stations with good volume. The author has had no difficulty in picking up numerous European and other foreign stations with excellent volume and regularity in New York City.

Examination of the circuit diagram reveals the use of two types 37 or 76 (Continued on page 305)

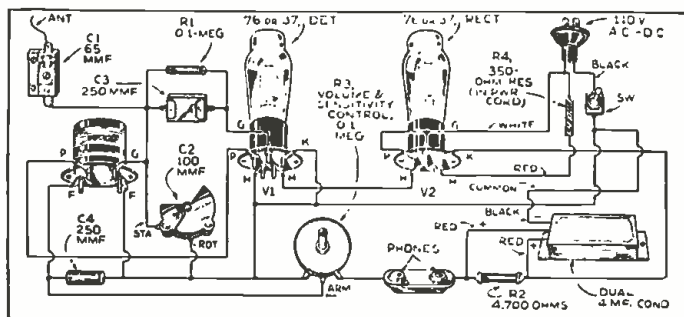

Fig. 1. Picture circuit of this easily-made set.



Fig. A. The set ready for operation.

THE DESIRABLE attributes of a portable receiver are (1) light weight, (2) compact size, (3) economy of operation and construction, and lastly, (4) enjoyable volume and sensitivity without the use of excessive antenna lengths.

Previous portables have ranged from bulky wood cases with built-in loops, to cigar box models with earphones—and all with contradictory features. The sensitive superheterodyne delivered good signal strength but the multitude of tubes required large and heavy supplies of batteries; while the low-powered sets were lacking in "wallop." Only the recent introduction of the new low-drain 2 V. multi-purpose tubes and a line of

AN EASILY-BUILT 4-TUBE PORTABLE SET

Portable sets are finding many applications, not only in the summer for vacation time, but through the entire year.

GUSTAVE L. KLEIN

midget portable batteries with comparatively long life make it possible now to fill a long felt need. The set shown here is the answer to this need as it comprises everything desirable in a portable set.

The circuit is of conventional superheterodyne design, and incorporates 2 iron-core I.F. transformers and high-

gain litz-wound tuning coils; very necessary features which provide accurate, sharp tuning and minimize the necessary antenna length. The entire set measures 14 x 10 x 5½ ins. high. The battery compartment contains 3 portable 45-V. midget "B" blocks; 1 3-V. midget "A"; and 2 7½-V. midget "C" (Continued on page 306)

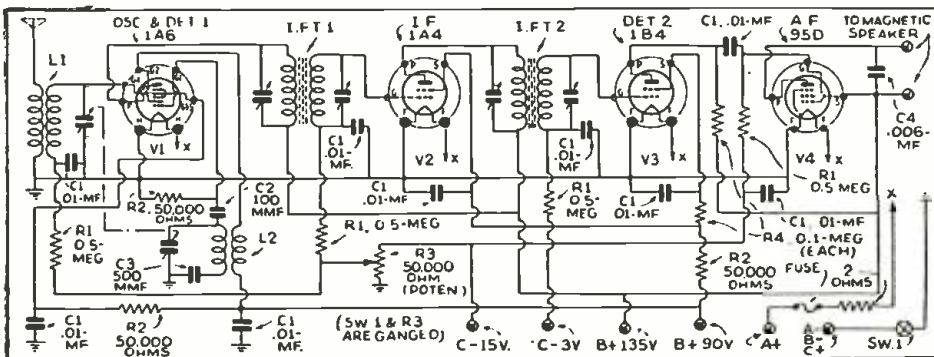

Fig. 1. The circuit of the 4-tube superhet. receiver.

MAKING A Q-TEST ADAPTER

Part II includes the constructional details for the Q Adapter—Part III will contain the calibration and operation of the instrument.

C. W. PALMER

PART II

LAST MONTH, in Part I, we discussed the need for a means of measuring Q in the experimenter's and Service Man's shop. In Part I, also, we explained briefly just what Q represents and explained the fundamental circuit of the Q tester. In order to prevent disappointment, let us repeat that it is necessary to have an oscillator which will supply an *unmodulated signal* at the frequency at which the Q of a coil, condenser, tuned circuit, resistor, etc., is to be operated, in order to use the Q Adapter.

It will be remembered that the fundamental principle of this new Service Man's tool, the Q Adapter, is based on the ratio of the voltage measured across a standard condenser to that measured across the same condenser in series with the impedance to be tested, the entire network being resonated to the desired frequency. These two voltages are measured by a vacuum-tube voltmeter, since this device is substantially free from frequency characteristics and will operate at very high frequencies.

Therefore, it is necessary that we have a dependable V.-T. voltmeter as the basis for our Q Adapter. In designing this voltmeter, a type 954 "acorn" tube was chosen, because of its very low input capacity which maintains a high impedance for the measuring circuit, even at extremely high frequencies.

In order to operate this V.-T. voltmeter from the A.C. power line and to eliminate the necessity for batteries, a rather special power unit was designed. As shown in Fig. 1, this consists of a 6X5 rectifier directly connected to the line, and a filament transformer supplying the heater power for the 6X5 and the 954. The filament transformer is used to insure constant filament voltage, so that the calibration of the voltmeter will be dependable, and to further insure this, a line voltage control tube is used. This is supplemented with a load resistor across the filament winding of the transformer which tends to stabilize the slight variations in load encountered when the tube filaments are used alone. (Unless the specified type of resistor is used the unit may not continue to carry the load for very long.)

A 3-way switch: (1) permits the voltmeter to be connected across the oscillator input, for adjusting the oscillator voltage to the correct point; (2) connects the V.-T. voltmeter

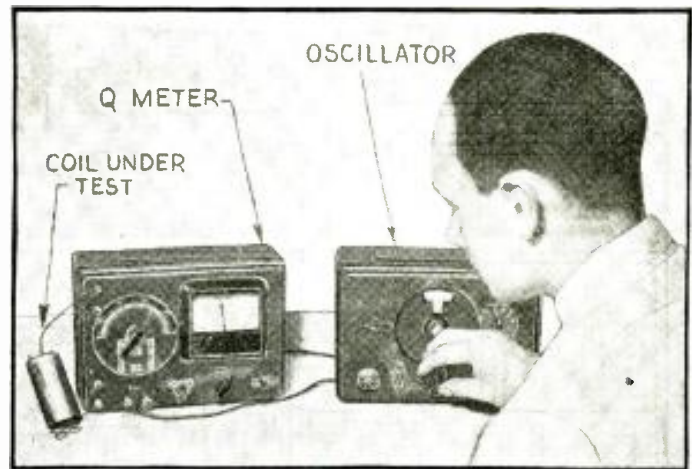

Fig. A. The Q Adapter with its companion oscillator.

to the circuit under test (for Q measurements); and, (3) connects the V.-T. voltmeter to external circuits for voltage measurement of high- and low-frequency alternating currents and direct current.

The condenser chosen for this Q tester is actually a finely-constructed transmitting unit using isolantite insulation, and a greater spacing between plates than is employed in the usual receiving type. The capacity range of the condenser is from 20 to 500 mmf.; and the capacity curve so closely follows a straight line increment of capacity that an even spacing of dial numbers can be used with negligible error in calibration. However, the constructor may wish to follow the writer's procedure and make on Bristol board an ink drawing of the dial (and while you're at it, drawings of the 2 switch-escutcheons), from which drawing any photostat house will be able to make a "negative photostat."** (See *Continued on page 318*)

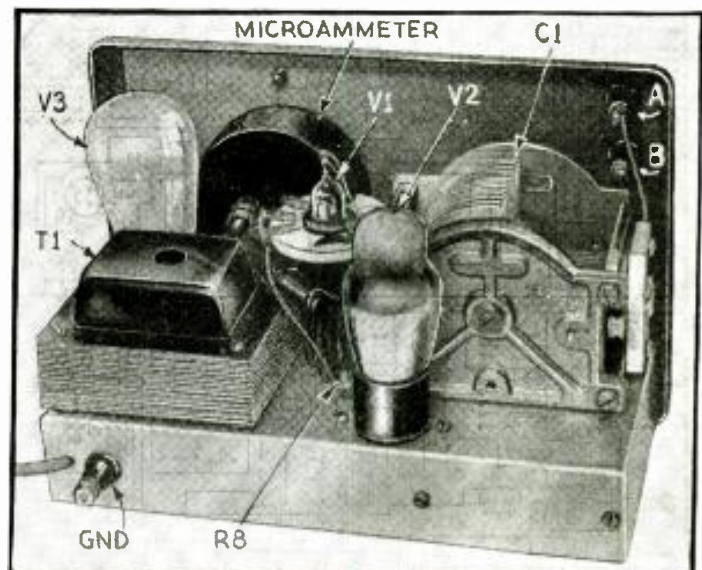

Fig. B. The inside of the instrument showing layout of parts.

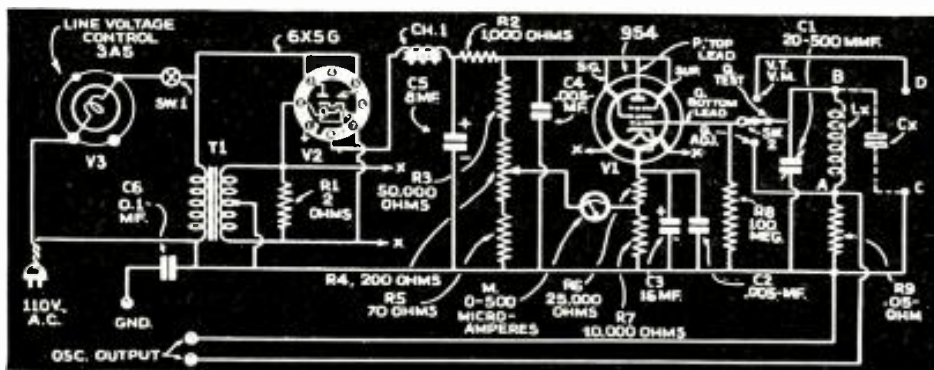

Fig. 1. The circuit, with values. A ground should only be applied through the 0.1-mf. condenser.

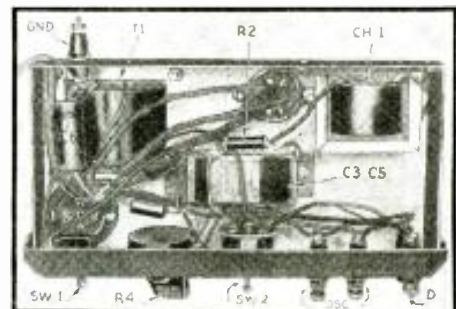

Fig. C. The under-chassis view of the instrument. Note that a common ground connection is made to the chassis, all ground leads being brought to this point.

HOW TO IMPROVE "TALKIES" FIDELITY

Part I appeared in Sept., 1936, RADIO-CRAFT. Part II covers amplifiers and acoustics. This is an article for the practical man.

LAWRENCE L. JOHNSON PART II

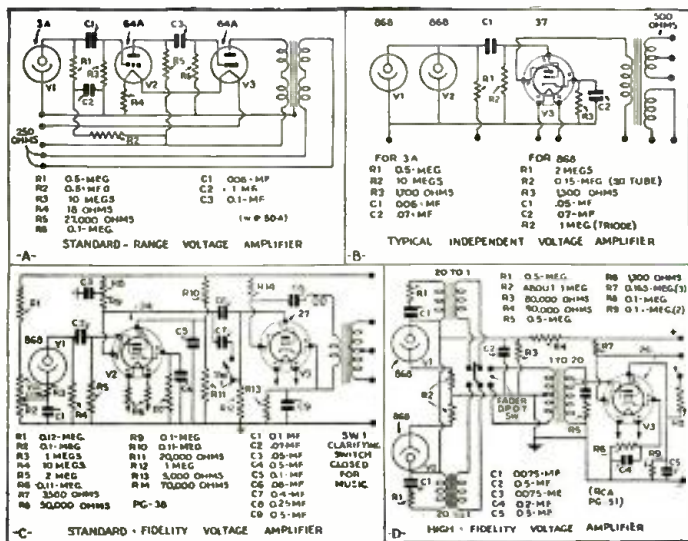

Fig. 3. Voltage amplifiers and coupling systems.

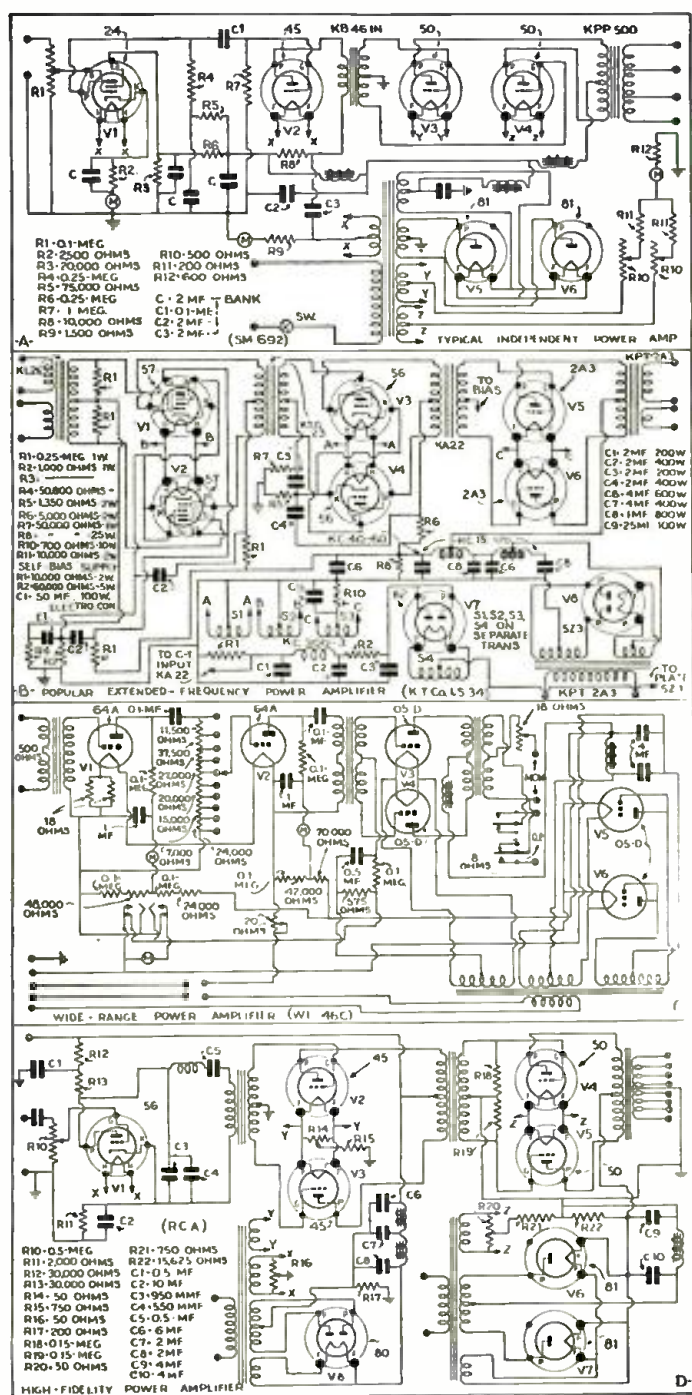

Fig. 4. Several types of power amplifiers.

THE VOLTAGE AMPLIFIER builds up the minute variations of the photoelectric cell until sufficient energy is obtained to drive or "excite" the power amplifier. It contains from 1 to 5 stages of vacuum-tube amplification. Modern developments have leaned toward the use of tubes having higher amplification factor (gain is computed from this); the use of tubes having indirectly-heated cathodes; the use of screen-grid tubes for voltage amplifiers is becoming popular; the use of parallel plate feed, because D.C. in transformers causes saturation of core materials and this, in turn, results in wave form distortion; and, finally, careful filtering of all P.E. cell circuits, plate circuits, grid circuits, and filament circuits. Improvements in photoelectric cells have also aided this line of development.

TYPES OF AMPLIFIERS

Figure 3A is a type of amplifier widely used by system A—one being mounted on each projector. Notice the resistance-capacity filter in the P.E. cell anode lead; that the filaments are wired in series with dropping or limiting resistor R4. A rheostat is used in the other filament leg to control the volume of each projector in order to match them.

In Fig. 3B we find the hookup used, in one form or another, by practically all of the independent manufacturers. This will be the type that the radio service engineer will encounter most often. The tube or tubes will most likely be 4-prong, direct-heater triodes. Remove these and use indirect heater tubes having higher amplification factors or, if you prefer, and feel capable, use a screen-grid tube. Values are given for 3A-type cell and RCA 868 cell (using screen-grid or triode). We urge at this point the inclusion of "varitone"-control (described in a past issue of *Radio-Craft*) and a separate 500-ohm input for microphone or phonograph service to be incorporated in the voltage amplifier output transformer. The *varitone* is connected across the output-tube plate winding.

Figure 3C is an interesting application of parallel feed, used in order to separate the speech and power circuits. Close inspection shows that it is thoroughly conventional and not as complicated as it appears. It is well filtered with resistance-capacity filter units.

Figure 3D is a *parallel feed*, transformer-coupled circuit used by system B in their high-fidelity installations. Resistor R2 is a complicated resistance-capacity network, "lumped" for convenience. Much of the circuit, from the first tube on, is like diagram 3C. Elimination of parallel feed simplifies this coupling immensely; the P.E. cell connects in series with a 90-V. supply and the primary winding of the P.E. cell transformer. The secondary may have an impedance of 500 ohms; or it may be a *grid* winding, if the distance to the voltage amplifier is short. This is, by far, the easiest method of changing over the P.E. cell coupling to extended frequency, and is recommended.

At this point, you are asked to look at Fig. 2, (in part I, September 1936 *Radio-Craft*) which is a wide-range voltage amplifier. Note that while the first tube might be parallel plate feed, it is also a type of impedance coupling used to prevent the increased output from the new type 3A P.E. cell from overloading V2. Attention is called to the grid filter at

(Continued on page 312)

PROS AND CONS OF MICROPHONE TYPES

A terse comparison of the five types of microphones which are commonly used for P.A., broadcasting and other types of communication.

JOHN ERWOOD

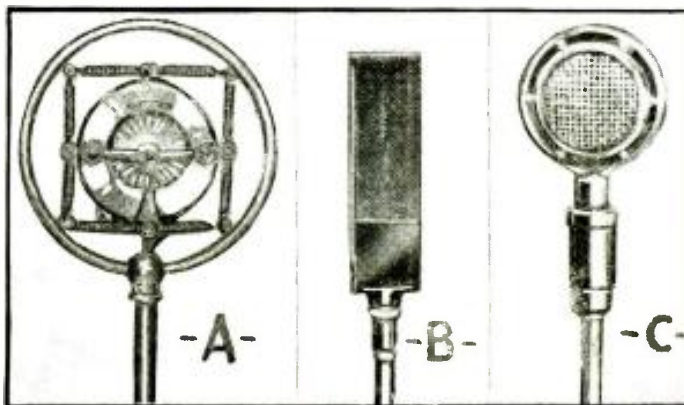

Three popular mike types—A, carbon type; B, Velocity or ribbon type; C, Dual-diaphragm crystal type.

THE RAPID advances in sound equipment have brought out the development of 5 distinct types of microphones.

Carbon Microphone. The carbon microphone consists of a stretched diaphragm across the center of which rests a loosely-packed pile of carbon granules in a carbon cup. Sound pressure waves, on striking the diaphragm, cause a lateral movement with a consequent increase or decrease of pressure upon the carbon granules. An electric current is maintained through these granules and the effect of changing pressure of the granules is to vary the resistance of the element. This causes a fluctuating current across 2 terminals mounted on either side of the carbon pack.

Advantages: It is low in cost, has a relatively high output and is of low-impedance type.

Limitations: It is limited in frequency response, its noise level is intrinsically high and increases with use, and the unit requires an exciting current for operation.

Velocity or Ribbon Type Microphone. This microphone does not require a diaphragm. It has a loosely-suspended ribbon maintained in an intense magnetic field. Sound-pressure waves hit against the ribbon, causing it to move. The ribbon cuts the field of the magnet, producing varying

potentials across the extreme terminals of the ribbon.

Advantages: It has a highly-directional pick-up range which is advantageous for indoor work. Its noise level is at a minimum. Its frequency response is excellent and is largely controlled by the design of its coupling transformer.

Limitations: This type of microphone is not a good device for close talking, giving "bassy" reproduction and is not particularly adapted to out-of-door work because of the delicately-suspended ribbon.

Crystal Microphone. There are fundamentally 2 different types of crystal microphones. One, a diaphragm type, which employs a sound cell with a diaphragm attached to some point on the cell. In the diaphragm type of crystal microphone, sound waves strike the diaphragm and vibrate the sound cell. The sound cell is so constructed that feeble currents are generated in proportion to both the amplitude and frequency of the sounds which strike it. This feeble electric current is then sent to the amplifier.

In the sound-cell type of crystal microphone, no diaphragm
(Continued on page 305)

THE BEGINNER IN PUBLIC ADDRESS

A treatise on feedback—that bug-a-boo of all P.A. workers, with some advice on speaker placement.

E. L. MELTON

NOT every P.A. beginner recognizes certain fundamental conditions when setting up a simple P.A. System. The following discussion of these fundamentals will serve greatly to smooth the path of the man who is making Public Address his vocation.

"Feedback." This term is commonly applied to those "howls," "squeals" and "whistles" that emanate from the loudspeakers when the "gain control" is advanced too far. It is caused by the speakers creating sound waves that extend as far as the microphone with sufficient intensity to actuate it and again become amplified and passed on to the speakers and thus continuing until the gain control is reduced. The frequency of this disturbance is usually of the same order as the resonant frequency of the microphone or speaker, or it may be a frequency at which the amplifier is most efficient. The most simple means of preventing it is to isolate the microphone from the

speakers but since this procedure is impractical in many installations we must consider other effective means.

"Close-Talking" Microphones. Microphones of the "close-talking" type are usually quite effective in reducing feedback. In most cases, however, they consist of a standard microphone in which the sensitivity has been reduced to such an extent that they will respond only to the stronger sound waves. This reduced sensitivity limits their use to "voice" reproduction since it is necessary that the sound input be at very close range, such as talking or singing directly into the microphone. This also necessitates additional amplification for a given output.

Tone Controls. Since feedback usually occurs at a relative high frequency, a tone control that attenuates the higher frequencies is often beneficial in reducing it. Proper adjustment of such a control often permits greater output from speakers before feedback occurs.



When Dr. Francis E. Townsend addressed the Cleveland national convention of Townsend Clubs, recently, he utilized 3 microphones to feed the P.A. system—a "bullet" (condenser mike and preamplifier), a "dynamic," and last but not least a "cue ball" crystal type.

SOUND DISTRIBUTION

For best results proper sound distribution and good quality of reproduction are of major importance in any installation. Good equipment, having power ratings well above those actually required for the job, is very essential. The use of overloaded or inferior equipment usually results in a system whose reproduction is unpleasant to the ear and actually worse than none at all.

Sound Distribution by "Force." This
(Continued on page 313)

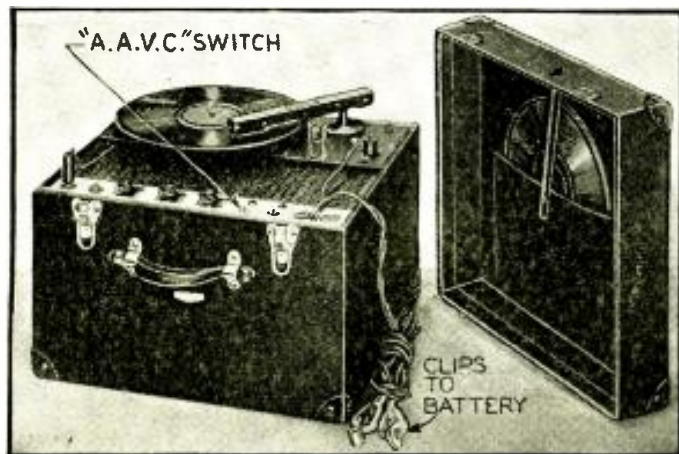

Fig. A. The appearance of the portable P.A. system.

HOW "AUDIO" A.V.C. OPERATES

Heretofore, proper P.A. operation has necessitated an expert technician's unremitting vigilance to manipulate the audio "manual" volume control, in order to compensate for the performer's movements near the "mike," changes in voice loudness, etc. The new "audio" automatic volume control or "A.A.V.C." system here described does it instantaneously, automatically!

INTRODUCING A NEW-TYPE "AUDIO" A.V.C. BEAM AMPLIFIER

Applying automatic volume control to the P.A. amplifier to improve speech characteristics.

A. C. SHANEY

IT SEEMS that the approach to electrical perfection as reflected in the high-quality amplifier of today has served to bring more definitely into focus the fact that an amplifier is more than just a series of electrical circuits and mechanical components.

Many desirable features which can now be found in modern P. A. amplifiers are not as yet listed in typical amplifier catalogs or tables of specifications, nor are they looked-for in the usual P.A. demonstration.

Strangely enough, P.A. technicians have not become aware of the fact that a P.A. installation does not become a complete and useful electro-mechanism until an orator starts talking into the microphone and an audience hears and understands the orator. The input of an amplifier does not begin at the microphone, any more than does the output end, with the loudspeakers—bones, muscles, nerves, habits, instincts and human temperaments of the orators, and of the audience must all be taken into account by the true engineer and designer of P.A. equipment.

The human element that should go into the design of P.A.
(Continued on page 308)

A COMPLETE OCILLOSCOPE "SERVICER"

A 1-unit oscilloscope, with sawtooth, sweep and fixed-frequency oscillators; frequency modulator; and, vertical and horizontal amplifiers. The circuit is given.

D. E. JOHNSON

IT HAS been the practice up to now to supply oscilloscopes for service and analysis work without the frequency modulator (wobbler) or oscillator, so essential to visual alignment and receiver analyses.

The instrument shown in Fig. A. contains all the usual elements of an oscilloscope, such as synchronizing, intensity, focus, and spot centering controls as well as a vertical amplifier, horizontal amplifier, and variable timing axis or sawtooth oscillator. In addition it contains a fixed frequency 1,000 kc. R.F. oscillator, a motor-driven condenser frequency-modulator, a fixed timing axis or sawtooth generator synchronized with the frequency modulator, and a jack for connecting the frequency modulator to an external R.F. oscillator.

Thus, it contains in one metal cabinet all the equipment required to service receivers. It may be used for all kinds of test work such as audio amplifier testing, waveform study, transmitter adjustment, vacuum tube characteristic

tracing and many other applications.

The vertical and horizontal amplifiers have a frequency range of 15 to 100,000 cycles. Switches are provided to turn off the amplifiers independently of each other, and for connecting the input directly to the deflecting plates.

The variable timing axis oscillator operates over a frequency range of 15 to 15,000 cycles, in 8 ranges. It uses a type 885 thyratron tube and a series of condensers and resistors for changing the frequency range.

The frequency modulator or wobbler consists of a motor-driven condenser which is used to modulate the 1,000-kc. fixed-frequency oscillator at 15 kc. each side of the carrier frequency. Two condenser capacities are available for the modulator, so that a choice of two band widths is available. The 1,000-kc. oscillator can be beat against an external variable-frequency oscillator for producing frequency-modulated signals for I.F. amplifier and R.F. amplifier alignment. It may be also used to produce

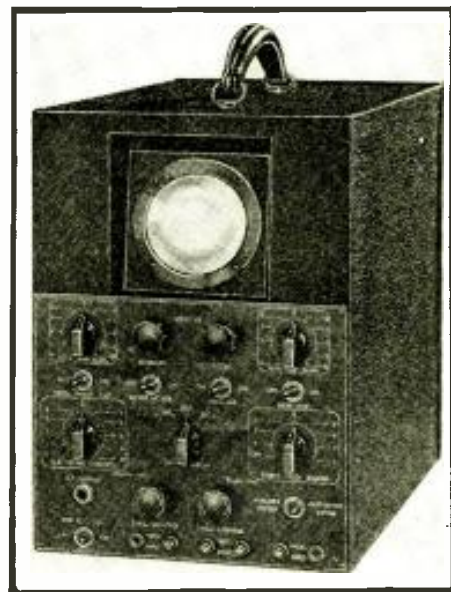

Fig. A. The front of the oscilloscope unit.

audio wobbling by correct use of an external oscillator, for A.F. amplifier adjustment.

The fixed timing-axis oscillator in the unit consists of a condenser charging circuit and a shorting commutator which works on the same motor shaft as the frequency modulator, thus keeping the output curve of a receiver on the fluorescent screen regardless of line voltage changes or changes in the speed of the wobbler motor.

(Continued on page 308)

HOW TO MAKE A DIRECT-IMPEDANCE BASS BOOSTER

The construction of an add-on booster for increasing fidelity of sets is detailed here.

L. MITCHELL BARCUS.....PART II

HAVING discussed the fundamental reasons for the low-note booster in last month's issue of *Radio-Craft*, we are now ready to undertake a description of the instrument itself.

An inspection of the schematic diagram, Fig. 2, discloses a 2-stage amplifier, resistance-capacity coupled, with a 6J7 and a 6F6 for maximum gain. The current supply is furnished by a typical power circuit utilizing a 5Z4. Every effort has been made to keep the unit as simple as possible, yet every source of possible extraneous noise has been checked.

Inasmuch as the unit is operating at a high level, care must be taken to eliminate any incidental rumblings which might detract from the pleasure to be had from it. For this reason, such details as shielding the input grid leads and filtering the current supplies to obviate any possible feedback or motorboating were found to be advisable. In addition, the unit is then mounted in a black-crackle steel box which thoroughly shields it from interference or from interfering with the main amplifier and receiver.

The low-frequency filtering is accomplished by means of the resistance-capacity trap circuit R5, C2 and C3. This provides for a rather sharp cut-off and allows only those notes below (about) 75 cycles to play any prominent part in the reproduced music. While the response tapers off above this point, the strength of the signals is not great enough to interfere to any considerable extent with the voice. Further filtering action is had by resonating the output transformer with C6 to approximately 30 cycles. This increases the efficiency in these regions by several decibels.

By means of the D.P.S.T. switch, Sw. 2, mounted on the front panel, we are able to cut out these filtering sections and convert the L.F. booster into a very efficient little amplifier with a response as shown in Fig. 1 (Part I). Considering the simplicity of the circuit, the overall frequency characteristics are excellent, holding up very well at both ends, and actually surpassing many circuits having much more pretentious claims. When used with a crystal pickup and the speaker for which it is designed, the unit has surprisingly good tone as judged by conventional standards.

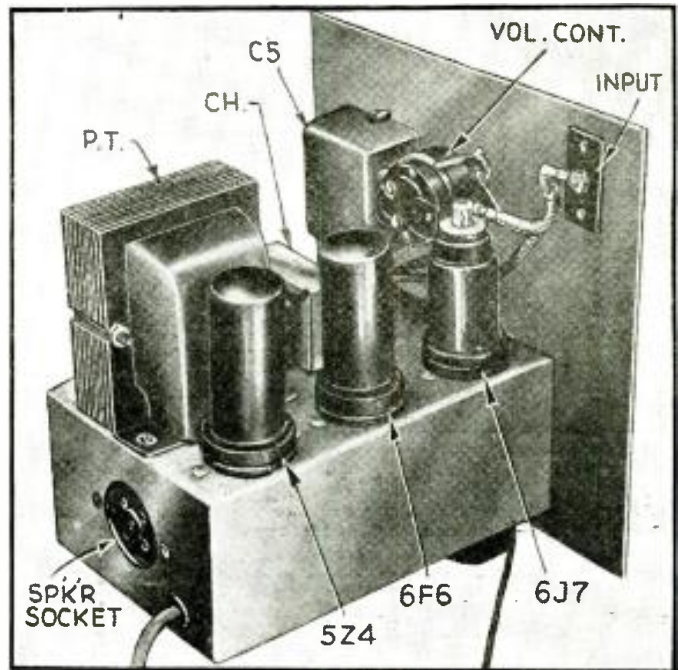

Fig. B. The rear of the chassis showing parts layout.

CONSTRUCTION

Because of the simplicity of the circuit, wiring difficulties are reduced to a negligible value. As may be seen from Fig. B, the actual component layout is such that associated parts are in every case close to one another, in this way eliminating long leads, cross-overs and considerable work. Rugged construction insures the unit against deterioration from the constant heavy vibration to which it is often subjected when placed near the speaker.

The chassis and cabinet are available with all socket and mounting holes ready punched so that the actual labor of assembly is largely eliminated. While the layout shown is not empirical, the constructor is advised to follow it as closely as possible in order that no unexpected symptoms will show up.

INPUT CONNECTIONS

The proper point in the amplifier to attach the L.F. booster is best determined by experiment. In the majority of the newer radio sets, the writer has had greatest success in tapping on to the plate prong of an output tube. Usually the hum level is low enough to permit this, and enough gain is had overall to permit the L.F. unit to be partially attenuated in output. In some cases, the L.F. response of the radio receiver, which includes the detector, is so low that the L.F. booster, despite its high gain, is unable to bring it up to a high enough level unless operating from the output stage. In other instances the second, or even the first audio stage will furnish the best L.F. signal, both from the standpoint

(Continued from page 314)

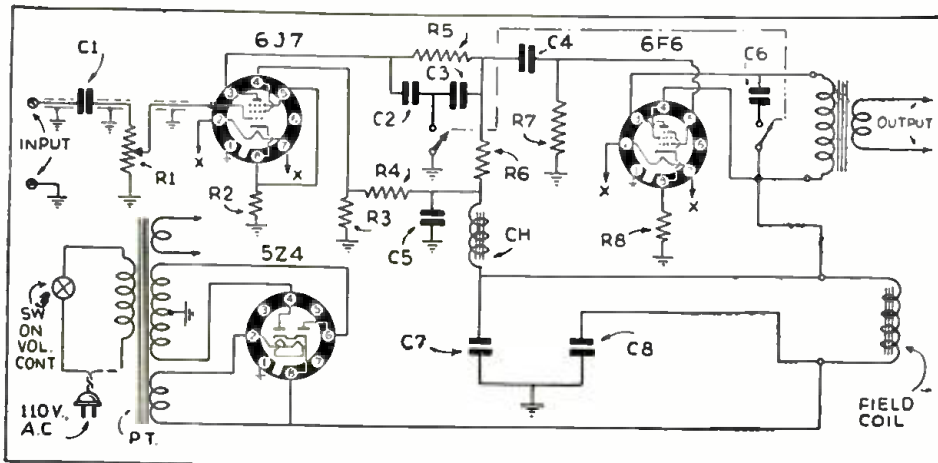

Fig. 2. The circuit. Parts indications refer to the List of Parts where values are given.

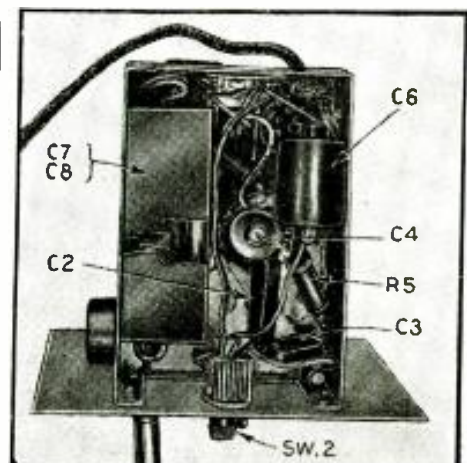

Fig. C. The underside view of the chassis.

PUTTING NEW TRICKS INTO OLD SETS

Details for modernizing the popular Majestic "66" to rival the latest auto-radio sets.

R. L. DOUGHERTY PART I

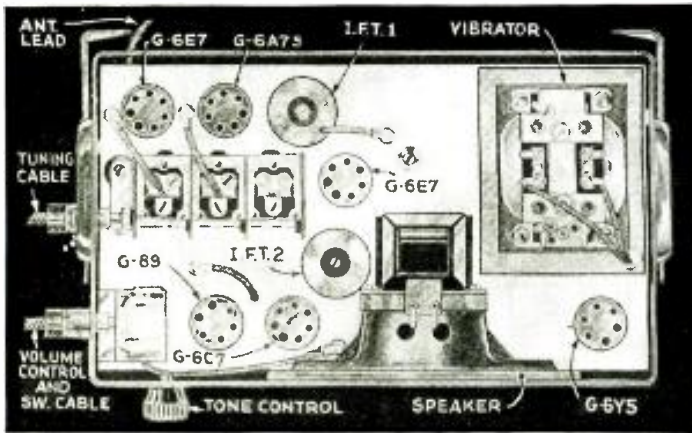

Fig. A. The appearance of the top of the chassis.

"IN THE SPRING, the young man's fancy—" where the radio man is concerned should read. "In the spring the radio man's income lightly turns to memories,"—unless he has learned from experience, and embraced refrigeration, sound or automotive radio as a spring and summer tonic and "builder-upper."

The writer has been directly connected with the automotive radio end of the game for the past several years, almost to the total exclusion of home radio, and while there are periods of slackness in the *car-radio* field, they are not nearly as sharply defined or prolonged as the summer slump in the *home-radio* field. There is a definite reason for this—the car-radio set is used almost daily, summer and winter, and consequently it goes out of order almost the same as does an integral part of the car itself, and hence money is spent almost as surely for repair of the car-radio set as for any regular mechanical repair to the motor, etc.

As a matter of fact there are in all the larger cities, places which specialize in car-radio installation and service, and show profits summer and winter. The installation field, in particular, is not nearly as crowded as is the home-service field, due mainly to 2 big factors: first, for successful operation of a regular installation shop, sufficient space must be made available to accommodate the cars that require radio service; second, the average radio man, knowing little or nothing about the successful installation of an auto-radio set, feels that he has insufficient knowledge of the subject. A more than "kidding" acquaintance with ignition systems must be on tap for the simple reason that it is sometimes necessary to make more or less of a change in the wiring or placing of integral parts of the ignition systems of a car in order to successfully eliminate that last little tick of "motor noise."

The successful and established radio man, however, can establish himself as an integral part of the auto-radio business, in a way that does not take into consideration either of the factors mentioned above in connection with installation. By that I mean *servicing* and *improving* sets that are already successfully installed in cars.

Along these lines, consider one of the

most popular car-radio sets of its day, the Majestic 66. Plenty of these sets were sold, and although they are now considered obsolete quite a number of them are still in daily service. As a matter of actual record there are less of these sets in the hands of "second hand" dealers than of any other automobile-radio set on the market. Why? Because these 66s are still being transferred by their original owners from one car to another. *They are good sets*, well built (mechanically strong), and are easily removed and installed. But—how they can be improved, using present-day circuit changes, is "money in the bank." As a matter of fact if one of these sets is given the "works" as described in the following paragraphs, the results will be such that the set will not have to bow to even the late 1936 sets with metal tubes and separate speakers! This is not just hearsay, as the writer has fixed up literally hundreds of this popular receiver and, believe it or not, each one has resulted in new customers and more than well-pleased old ones. There is no reason why other Service Men cannot do the same!

"BEFORE" AND "AFTER" CIRCUITS

Let us take a look at the Majestic "66." Figure 1 illustrates the original circuit. It is largely conventional—a superheterodyne using an intermediate frequency of 175 kc. It is very selective and because of the low I.F. it is free from images, tweets and blurps. Also it incorporates a 3-gang condenser, which contributes to the sharpness of tuning. The circuit sequence is: 1 stage of tuned R.F.; composite modulator-oscillator, using the 6A7 tube; 1 stage of high-gain (*but not too sharply tuned*) I.F.; this is followed by a diode detector, A.V.C. and 1st A.F., combined in one tube; and, a fairly decent pentode output. The A.V.C. action is effective on the first 3 tubes. The vibrator and rectifier, which in this case is of the mercury-vapor type, a system used only by makers of Majestic sets, is one having very bad features.

The tubes used make the Service Man gasp the first time he sees one of them—look at the line-up and find out what they really are. First (see Fig. 1) comes the R.F., a G-6E7S, which is actually a
(Continued on page 317)

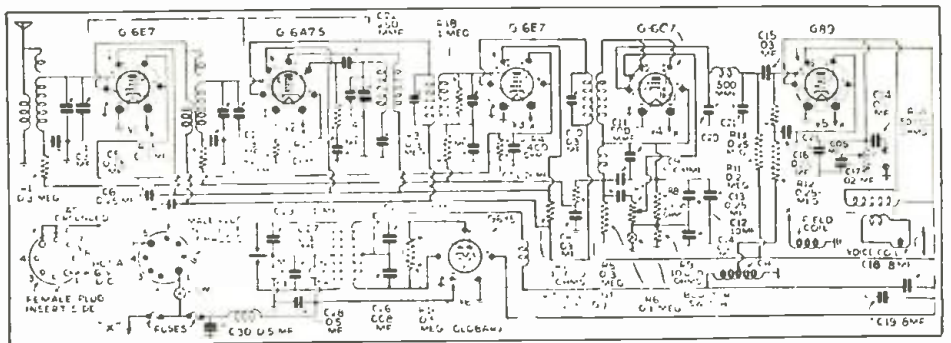

Fig. 1. The circuit in its original form, before it is brought up-to-date.

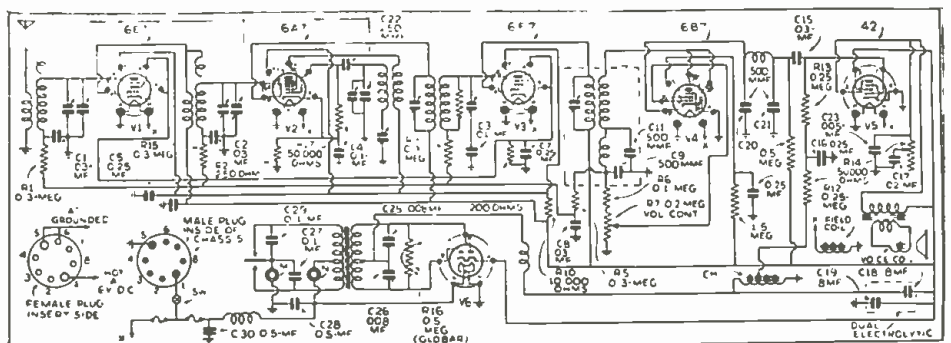

Fig. 2. The "66" after the changes have been made according to instructions.

ELECTRONIC MUSIC FUNDAMENTALS

In answer to the many requests received regarding electronic music patents, the author has made a resumé of the subject.

EDWARD KASSEL

PART VI

NUMEROUS letters have been received from our readers, including experimenters, and musical instrument builders, regarding the 5 preceding articles titled, "Electronic Music Fundamentals." The most important questions brought up are those concerning dates of development in order to avoid the possibility of infringement, and also have the full benefit of results of run-out patents. We have had queries on various features used in electronic music, which can be found in text books, or in old publications on the subject, which features, of course, are not patentable.

CLASSIFICATION OF ELECTRONIC MUSICAL INSTRUMENTS

The several types of electronic musical instruments can be classified as follows:—

a. **Electronic musical instrument.** A device which has a unit for generating electro-magnetically, photoelectrically, or electrostatically, by means of vacuum tubes, etc., pulsating electric currents of different frequencies; and musical pitches (of instrument) that exist only when instrument is in operation. (Does not have tuned strings, reeds, forks, etc.) In this category are included the instruments of Cahill, several Eremeeff types of instruments, Hammond, Martenot, etc.

b. **Semi-electronic musical instru-**

ment. A device which has an electro-mechanical unit and amplification medium for picking up electromechanical vibrations caused by the action of a keyboard—for example, an electric piano with standard key actions, a set of strings tuned to different pitches, and electromagnetic or electrostatic multi-amplification system. This type includes several models of electric pianos made by a German telephone and telegraph company, and by Meissner, Baldwin, etc., and reed organs, as the Orgatron.

c. **Electrically amplified musical instrument.** A device which is really a conventional musical instrument, such as the piano, organ, double bass, guitar, etc., which has been conveniently amplified with the aid of a microphone, electromagnetic or piezoelectric pickup, etc., and this type includes the Vox-Humano and Gulbransen organs, Eremeeff double basses, and a number of electric guitars at present on the market.

REFERENCES ON ELECTRONIC MUSIC

In order to be well-posted with developments in electronic music, the designer and experimenter must have fundamental information as to the patent situation, well-known methods of practice, designs, and necessary data, etc., as follow (in numerical order):

1. The simple method of generation of electrical tones by the commutator



Fig. 1. An electronic pickup for converting musical instruments into electronic instruments. The "contact-type" microphone attaches to the instrument by means of a rubber suction cup (see inset).

is well-known and can be applied to the construction of electronic musical instruments without fear of infringing on some patents. It has been used in telegraphy and telephony, and if there are any patents pertaining to the application of the commutator for the production of musical tones electrically, they are old and run out, for example, the Cahill patent of 1897, No. 580,035.

2. The adaptation of the phonic wheel or tone wheel for the generation of the electrical tone goes back to the invention of the magneto. This method has already been used in telegraphy and telephony, and was first described in the Berliner patent of 1882, No. 258,356.

3. The photoelectric principle for the generation of electrical musical tones originates from experiments with the selenium cell—applications for the production of tones with the aid of light. See the Mercadier patent of 1890, No. 420,884.

4. The generation of tones with the aid of the film (*non-periodic* wave pattern) dates as far back as 1880, in the Fritz patent, No. 1,203,190. Film with *periodic* wave pattern, multi-track, as used for musical instruments, was first made by Eremeeff, patent, Nos. 1,990,024 and 2,030,248.

5. The production of tones with vacuum tubes was accomplished by de Forest in 1915.

6. The origination of tone with the stylus dates as far back as the invention of the acoustical phonograph by Koenig in 1859, and recently made possible electrically, with the adaptation of the electrical pickup and amplifiers.

7. The production of different qualities of tone by synthesizing the fundamental with partials and harmonics dates back to Helmholtz:—see the book, "Sensation of Tone." For the origination of qualities of tone by combining the fundamental with sub-partial and sub-harmonics, see Eremeeff patents Nos. 1,924,713 and 2,031,764.

8. Many laboratory experiments are being made with electro-tone production, and a number of instruments are being made for producing musical tones, but

(Continued on page 316)

	0	1	2	3	4	5	6	7
C	16.35	32.70	65.40	130.81	261.62	523.26	1046.52	2093.04
C#	17.32	34.64	69.29	138.59	277.18	554.36	1108.72	2217.44
D	18.35	36.70	73.41	146.83	293.67	587.34	1174.68	2349.36
D#	19.44	38.89	77.78	155.56	311.13	622.26	1244.52	2489.04
E	20.60	41.20	82.41	164.82	329.63	659.26	1318.52	2637.02
F	21.82	43.65	87.30	174.61	349.23	698.46	1396.92	2793.62
F#	23.12	46.24	92.49	184.99	369.99	739.98	1479.96	2959.95
G	24.49	48.99	97.99	195.99	391.99	783.98	1567.96	3135.96
G#	25.95	51.91	103.82	207.65	415.31	830.62	1661.24	3322.48
A	27.50	55.00	110.00	220.00	440.00	880.00	1760.00	3520.00
A#	29.13	58.27	116.54	233.08	466.17	932.34	1864.68	3729.36
B	30.86	61.73	123.47	246.94	493.88	987.76	1975.52	3951.04

MANUAL
MANUAL
PEDALS
32 CYCLES C 65 CYCLES
2093 CYCLES C

Fig. 16. Complying with requests—a correct table of musical frequencies, pitch A=440.

DETROLA MODEL 105C 5-TUBE DUAL-BAND A.C.-D.C. SUPERHETERODYNE

(Features: new design; ranges, 70 to 200 meters, and 200 to 550 meters; antenna wavetrapp; hum bucking coil.)

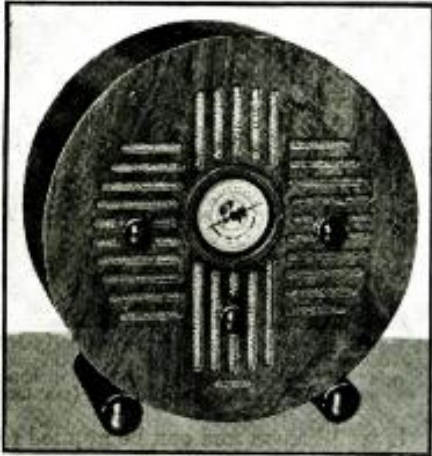

The high-voltage D.C. in this receiver is 120 V. from "B+" to "B-," and 105 V. from "B+" to chassis, the difference of 15 V. being the drop in the filter choke that is applied to the C.-G. of V4. These voltage values hold true with a line voltage of 115 V. Alignment procedure is as follows: align the 1st and 2nd I.F. transformers to 370 kc., with the output from the signal generator connected between the grid cap of V1 and the chassis. Then connect generator to antenna and adjust wavetrapp, located on right-front of chassis, to point of minimum receiver output with 370-ke. input. Open receiver gang condenser to minimum capacity and adjust the receiver to 1,650 kc. with the rear trimmer on the gang condenser. Tune in 1,400-ke. signal and adjust front trimmer on gang condensers to maximum. Tune in 600-ke. signal and while rocking condenser slightly back and forth, adjust padder located on top of chassis between variable condenser and speaker, to best response. Repeat alignment at 1,650 and 1,400

kc. Use a 250-mmf. condenser as a dummy antenna. For alignment of the short-wave band use a 400-ohm resistor as a dummy antenna. Adjust antenna trimmer on band switch, on underside of chassis, for a peak at 4 mcs. No other adjustment is necessary on this band. An average antenna length is about 50 ft., but may be longer when the receiver is located at a distance from any powerful stations, and should be made shorter to gain higher selectivity when the receiver is near such stations. Under no conditions should a ground connection be made. When the receiver is to be used on a D.C. line it is necessary to have the plug properly polarized. If the receiver does not operate after the plug has been in the socket for about 2 mins., remove plug and reverse it to change polarity. Occasionally, on A.C. lines, a loud hum will be heard as stations are tuned in. Reverse the power plug, and if this does not stop the noise, it may often be stopped by grounding other sets or appliances in the house. Don't ground set.

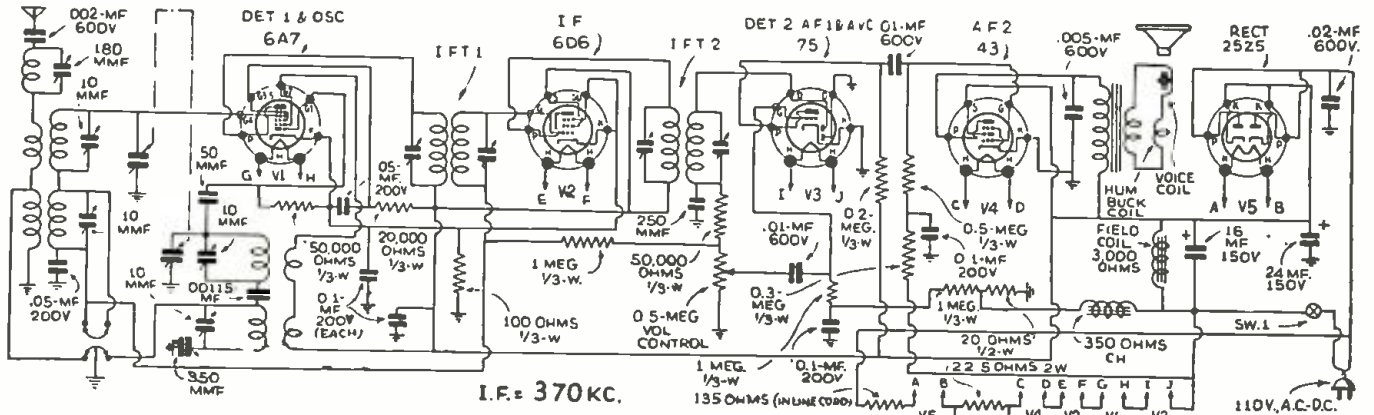

INTERNATIONAL MODEL 500 5-TUBE DUAL-RANGE BATTERY SUPERHET.

(Features: ranges, 18 to 55 meters, and 180 to 555 meters; magnetodynamic speaker; modern design; all batteries contained in cabinet.)

The tube voltages from socket prongs to ground are shown in the following table:

Tube	Plate	S.-G.	C.-G.	Filament
V1	110	45	-2.8	2
V2	110	45	-5.6	2
V3	110	45	-5.6	2
V4	35	—	0	2
V5	105	112	-12	2

The minus side of the filament is grounded. For the "A" battery supply of this receiver it is essential that the voltage be kept as near as possible to 2 V. The easiest way of being certain of this is to use a single storage cell. The aircell type of battery, while

it cannot be recharged, is also very satisfactory. If a storage cell is used, it should never be recharged while it is connected to the receiver. If dry cells are used, a series resistor should be used to cut the supply from 3 V. down to the needed 2 V. The battery connections are color coded as follows: red, "B+" 135 V.; white, "B+" 67½ V.; green, "B+" 22½ V.; black, "B-"; yellow, "A+"; blue, "A-". Alignment of the I.F. circuits is accomplished by connecting the output of the test oscillator directly to the antenna, and at the same time shorting the oscillator section of the tuning condenser gang of the receiver. All 3 transformers should be carefully adjusted, starting with the one

next to V1. Then turn receiver dial to 1,400 kc. and feed a very weak 1,400-ke. signal to the set, and adjust the oscillator trimmer, which is located on the end of the 3-gang trimmer nearest the chassis. As there is no series padder, resonance at low frequency is had by bending the plates of the tuning condenser. This should be done at 1,000 and 600 kc. Set the test oscillator to 15.5 mcs. and adjust the trimmer at the other end of the gang, with the receiver tuning dial set at 15.5 mc. Next turn to 12 mc. and adjust the S.-W. detector trimmer. Alignment at 6 mc. on this band is accomplished by spreading or crowding the turns on the S.-W. detector coil.

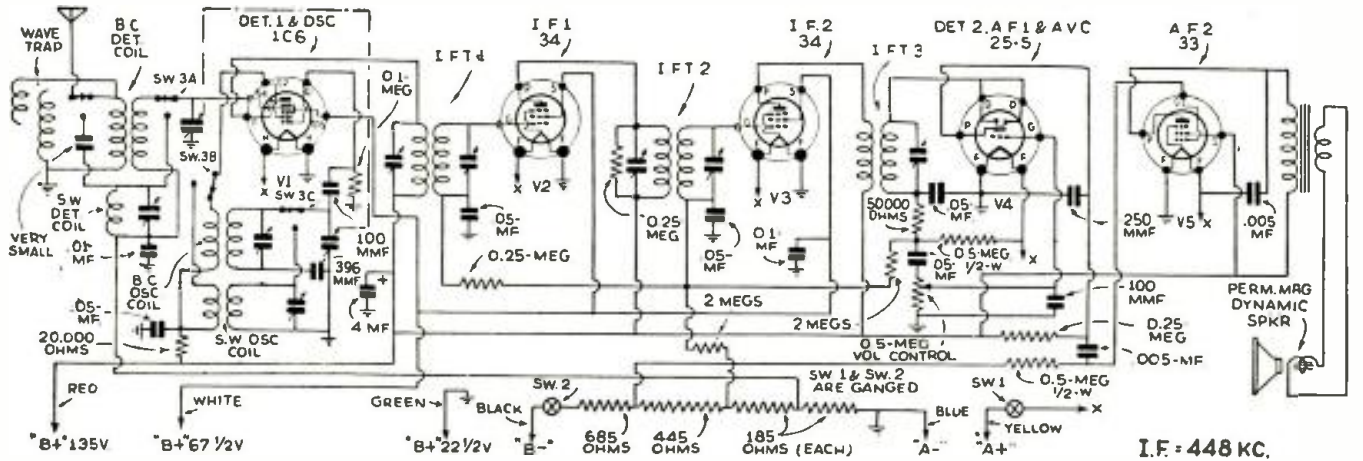

TWO PRECISION TESTERS

FOR THE PRICE OF ONE

Each Ranger-Examiner Combination puts together in one case two (2) units of test equipment every serviceman needs in his everyday work. The savings effected in design and in using this exclusive Ranger-Examiner grouping permits offering these combinations of two Precision Testers at prices you would normally expect to pay for one.

Each item is precision built throughout by the oldest company in the service equipment field. Their past contacts with the trade as well as with every advancement in the field of radio make them fully acquainted with the needs of the service profession. From the standpoint of sheer merit Ranger-Examiner testers are becoming popular favorites.



COMBINATION FREE POINT TESTER AND VOLT-OHM-MILLIAMMETER MODEL 640-740



Model 640 Free Point Tester has five (5) sockets. Panel includes automatic switch type and single action jacks.
 Model 740 VOLT OHM MILLIAMMETER Unit has a Triplett Precision Instrument scale reading 10-50-250-500-1000 A.C. and D.C. volts at 1000 ohms per volt. 1-10-50-250 M.A.; low ohms 0-300; high ohms to 250,000 at 1.5 volts. Rheostat adjustment.
 Model 640-740 is contained in the standard size metal carrying case above described.
 Dealer Price ... \$27.00

ADDITIONAL COMBINATIONS

Using the same standard size metal carrying case the following additional combinations may be had; the testers in all cases being identical with foregoing descriptions and complete with necessary accessories.

Model 540-740 Signal Generator and Multimeter Dealer Price \$36.00
 Model 440-740 Tube Tester and Multimeter Dealer Price \$37.50

DIRECT READING SIGNAL GENERATOR MODEL 557



Model 557 has the same features as described for Signal Generator Model 540 except that it is installed in a black leatherette carrying case and is an integral part of the case. The five individually calibrated coils are tested on the side as shown, handy for instant use. The attractive panel is silver and black.
 Dealer Price \$18.00
 Model 554-A is the same as Model 557 but not direct reading. Calibrated graphs included for accuracies under 1% on any band.
 Dealer Price \$14.40

COMBINATION TUBE TESTER AND SIGNAL GENERATOR 440-540



COMPLETE DEALER PRICE \$33.60

Model 440-540 has the two separate testers installed in a sturdy metal carrying case for shop or field use.
 Model 440 Tube Tester checks all type tubes. Condition of tubes is read directly on GOOD-BAD instrument scale while load values are applied. Circuit designed to indicate inter element shorts and leakages. Illuminated dial A.C. instrument for line volts adjustment, also shows when tester is connected to power supply.
 Model 540 Signal Generator uses plug-in type coils. Five frequency bands cover 110 to 20,000 K.C. All readings are direct and fundamentals. Each coil is individually calibrated by peaking with Trimmer condensers. Accuracy, within one percent (1%) from 110-3000 K.C.—2% for higher readings. Completely shielded. Attenuation and stability are outstanding features. Complete with coils, two type 30 tubes, batteries and necessary accessories.
 Model 440-540 consists of these two instruments installed in a sturdy metal case with built-in compartment having snap on cover for accessories, finished in electro black baked enamel, panels in silver and black. Every essential feature is incorporated in these outstanding instruments. No extravagance. No added unnecessary cost. To see one—to use one—means you will be glad to own this outstanding tester.

D.C. POCKET VOLT-OHM-MILLIAMMETER MODEL 735

Contained in sturdy black molded case with silver and black panel, rounded corners. Ranges are 15-150-750 volts; 1.5-15-150 M.A.; 1/2-1,000 low ohms; 0-100,000 high ohms at 1.5 volts. Provision for external batteries to be used for higher resistance measurements.



Has Triplett D'Arsonval precision instrument accurate to 2%. Selector switch for all ranges. Provides for all D.C. measurement requirements of the serviceman.
 Size is 3 1/16" x 5 1/2" x 2 1/4" deep—is easily carried in the pocket, and handy for the laboratory. Complete with battery, test leads and alligator clips.
 Dealer Price \$10.80

SEE THEM AT YOUR JOBBER — WRITE



READRITE METER WORKS
 1116 College St., Bluffton, Ohio.

Without obligation please send me more information on
Ranger-Examiner Combination

Name

Address

City State

ZENITH 6-TUBE ALL-WAVE SUPERHET. CHASSIS No. 5634

(Features: antenna wavetrap; uses either metal or metal-glass tubes; bass compensation. Set models 6-S-128, 6-S-137, 6-S-147, 6-S-152, 6-S-157.)

This chassis is used in receivers Nos. 6-S-128, 6-S-137, 6-S-147, 6-S-152, and 6-S-157. The operating voltages are as follows:

Tube	Plate	S.-G.	C.-G.	Cathode
V1*	280	0	0	0
V2	280	80	0	7
V3	—	—	—	—2
V4	75	—	—	—2
V5	260	280	—2	—2
V6	A.C.	—	—	320

*The anode grid of V1 is 175 V. All measurements are made with a 1,000 ohms-per-volt meter, from socket to ground, and with the antenna and ground disconnected. The line voltage for above readings is 112 V. Power consumption of the receiver is 75 W.; the power output is 4 W. The I.F. stage is

aligned by connecting the leads from the signal generator to ground and the control-grid cap of V1. Set test oscillator at 456 kc. and adjust all 4 trimmers for highest output. Then change leads to antenna and ground of receiver and adjust the wavetrap for minimum output reading. Set generator at 6 mc. and adjust oscillator trimmer on gang condenser for correct dial reading on band B. Set generator to 1,400 kc. and adjust osc. trimmer of band A for dial setting, also adjusting antenna trimmer for best output. Set generator to 18 mc. and align receiver dial at this position for highest output. Set generator to 600 kc. and rock receiver dial on band A to best output. Readjust trimmers at 1,400 kc.

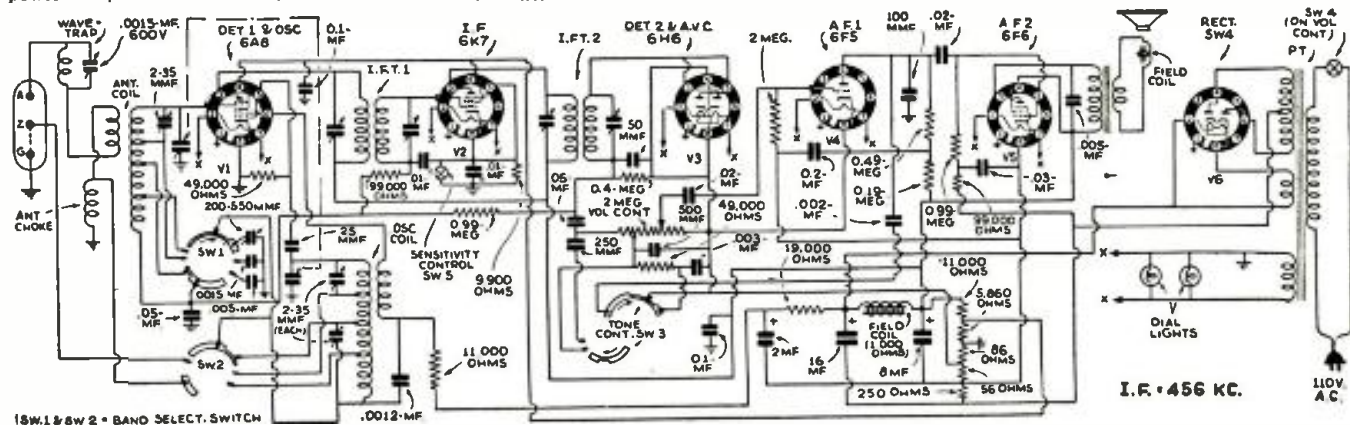
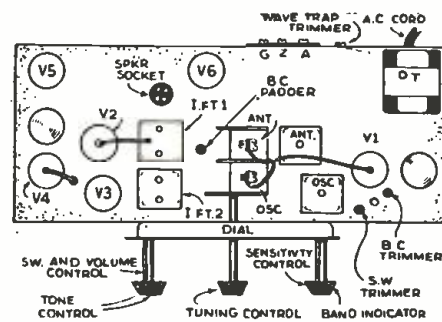

FAIRBANKS-MORSE 9-TUBE ALL-WAVE MODEL 91 SUPERHET. CHASSIS

(Features: beam output tube; tuning ray tube; separate h.-f. osc.; range, 540 kc. to 65 mc. Sets models 91T4, 91C4 and 91C5.)

Voltages for this receiver are as follows:

Tube	Plate	S.-G.	C.-G.	Cathode
V1	250	130	0	3.6
V2	250	130	0	5.5
V3	250	130	0	8.5
V4	—0.35	—	—	0
V5	120	—	0.2	0
V6	275	265	—0.1	0
V7	—90	—	—	310
V8	6.5	—	—0.1	0
V9	175	300	—2.2	0

These voltages are measured from the tube socket prongs to ground. Alignment should be made with the volume control of the receiver on full, and any attenuation made with the gain control of the test oscillator. Align the I.F. stage at 456 kc. and the tuning condenser set at full mesh, band switch on broadcast position. The lead to the set from the

test oscillator is connected to the cap of V2 through a 0.1-mf. condenser. Adjust all trimmers to the highest possible output. Turn the receiver dial to 1,500 kc. and connect the test oscillator to the receiver antenna lead through a 200 mmf. condenser. Adjust the B.C. oscillator trimmer for highest output, then adjust the detector and R.F. trimmers likewise. Tune to 600 kc. and adjust the B.C. band series padder to highest output, while rocking the tuning condenser to the best position. The next band is adjusted the same way at 5.4 mc. and 1.8 mc. The dummy antenna for this band is a 400-ohm carbon resistor in series with the antenna leads. The short-wave band is adjusted at 18 mc. and 6 mc. The same 400-ohm series resistor is again used. The image signal should be received at about 17 mc. on the dial. If it

is not, the receiver must be readjusted so that the image comes in at this point, when the correct signal comes in at 18 kc. No adjustment is required on the ultra-short wave band. If signals are not received on this band, the oscillator tube, V9, as well as the switch contacts, the fixed padding condenser and the coils should be checked. It should be noted that the oscillator tickler coils in this receiver are in the oscillator cathode circuit. The coils for the ultra-high frequency band consist of 3 pieces of bus bar, and care should be taken not to disturb these pieces. The automatic bass compensation circuit acts to increase the low-frequency response of the A.F. system at low volume levels. A special antenna system is provided by the makers for this receiver to insure best possible results.

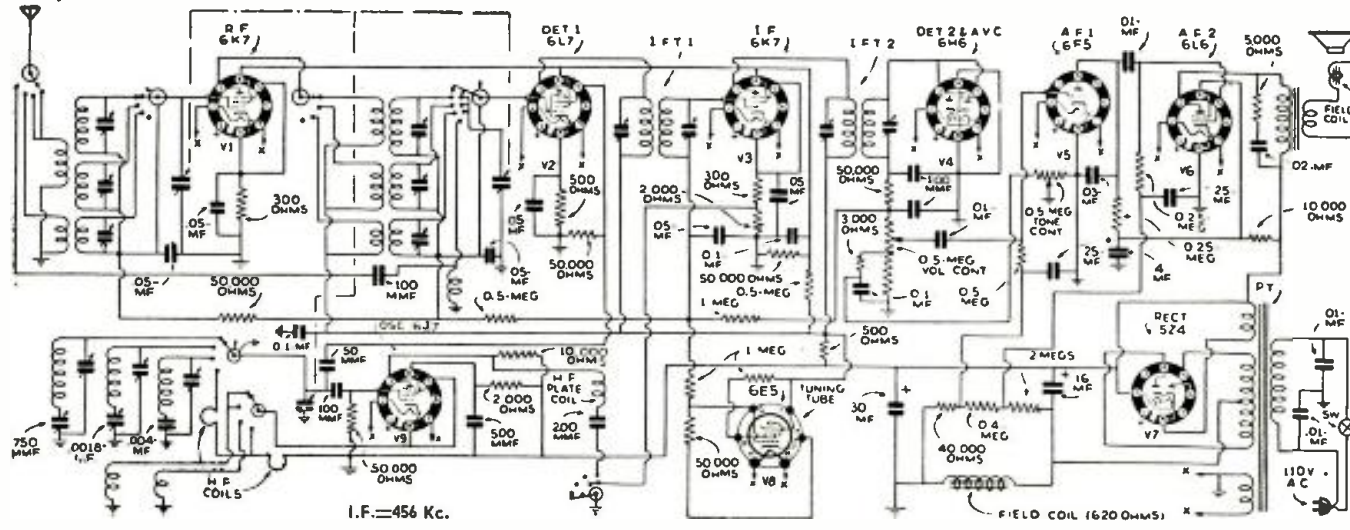

THE RADIO MONTH IN REVIEW

(Continued from page 265)

short time ago, plans were completed for air traffic control in an effort to avoid plane accidents. This traffic control will determine the altitudes at which planes traveling on the national airways, will fly.

Construction was started on the new 640 ft. mast for station WJZ which will improve the service area of this popular broadcaster.

It was announced by Dr. Donald Menzel of Harvard Observatory that the observations of the recent total eclipse in central Asia showed that disruption of short-wave communication was due to a movement of the electrified layers above the earth and that these layers probably consist of extremely intense radiations in the far-ultra-violet part of the solar spectrum.

RCA announced that a convenient time payment plan had been worked out for the purchase of their test equipment.

And it was rumored that the efficiency experts introduced into the NBC by its new president, Lohr, have been thrown high and dry by one of the creative program writers who has been listing on his daily report this item: "2:06 P.M.—Thinking."

TEST LAW TO REDUCE MAN-MADE STATIC

An ordinance designed to test the plan of the National Committee for the Control of Radio Interference, mentioned in the Editorial of *Radio-Craft*, October 1936 issue, was passed by the council of East Rockaway, L. I., New York, last month.

While intended to remove the interference from the electric railways in the vicinity, this ordinance has a nation-wide effect in testing the authority of communities to enforce such laws!

DR. WESTON DIES

Dr. Edward Weston, 56-year-old scientist, inventor and former president of the Weston Electrical Instrument Co. died last month at his home in Montclair, N. J. following a cerebral hemorrhage.

During his career, Dr. Weston held patents on more than 200 electrical devices, including those which made the electric dynamo practical and which was, perhaps, his greatest contribution to science.

Born in Shropshire, England, Dr. Weston was started in a career of medicine by his parents, but after serving an internship near London, he decided to substitute the electrical science for medicine. Shortly after, he came to America, after which started his brilliant career as chemist and electrical research worker.



The late Dr. Edward Weston.

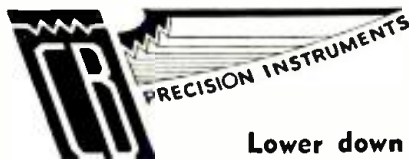

are easy to buy
on **THIS** liberal plan

Lower down payment—Easy monthly payments

Command Top Prices for Your Services with C-B Instruments
Study these specifications!



MODEL 99

percentage of modulation. Metal tubes included. **\$43.90**
Net cash
(Only \$5.00 down and ten monthly payments of \$4.44)

MODEL OM-A R-F Signal Generator. The new "INDUCTOR SWEEP" wobbulator and a straight sine wave modulated r-f oscillator in one unit! Necessary for accurate selectivity curve delineation on Cathode-ray oscillograph screen. Fundamental range of 100 kc to 30 mc, with guaranteed accuracy within 1/2 of 1% with fixed-width plus and minus 20 kc sweep. Hand-calibrated against Arlington checked precision crystal fundamentals! The "INDUCTOR SWEEP" circuit developed in the C-B laboratories offers an outstanding advance in stability and ease of operation. Metal tubes included. **\$57.75**
Your net cash price
(Only \$6.50 down and ten monthly payments of \$5.85)



MODEL OM-A



MODEL CRA

It's a joy to work with this ray oscillograph. Net cash **\$84.50**
(Only \$9.50 down and ten monthly payments of \$8.36)

"Pay-As-You-Earn"

The NEW liberal plan for easy time payments permits you to immediately start earning with these new instruments. Note the lower down payments! Let these business building instruments start paying for themselves in the added profits which result from the use of laboratory-type equipment. See your C-B jobber today, or mail the coupon for new catalog and application form and learn how you too can enjoy fine equipment!

Mail Today
for
Time Payment
Application
Form

The CLOUGH-BREngle CO.

2809 W. 19th St., Chicago, Ill.

Rush us full details on all instruments in the new C-B SUPER SERVICE line and "Pay-As-You-Earn" application form.

Name

Address



Complete Service Laboratories!

Rack and panel style foundation cabinet for bench use may be purchased in any of the combinations listed below. All C-B instruments are now offered optionally in 19-in. rack mounting style panels. Series 1000, as illustrated above, net cash \$299.50, down payment \$33.70.

Series 1010, same less MODEL 95, net cash \$249.50, down payment \$28.00.

Series 1010 includes MODEL OC-A r-f Signal Generator and MODEL 95 Super-Unimeter in Laboratory Cabinet Rack with Lumaline Floodlight, net cash, \$104.50.
Down payment only \$12.00.



MODEL OC

This popular all-wave signal generator is continuously variable on fundamental frequencies from 100 kc to 30 mc through five tuning bands. Calibrated against Arlington time checked crystal frequency standard, guaranteed within 1/2 of 1% frequency accuracy. Metal tubes are used in MODELS OC-A and OC-B. Compare these new OC MODELS with any similar instrument for engineering, performance, and value!

MODEL OC-A R-F Signal Generator for operation from 110 v. 50-60 cycle line, complete with tubes and calibration **\$29.95** curves, net cash

MODEL OC-B, same as OC-A but for 110 v. ac-dc **\$29.95** operation, net cash ..

MODEL OD-A, same as above but for operation from self-contained battery supply (less batt.). **\$29.95** net cash

Above models, \$4.50 down and seven monthly payments of \$4.20.

Here's the Key to SUCCESSFUL SERVICING

STUDY ADVANCED RADIO SERVICE AT HOME

The service field is overcrowded with men who are "pretty good". There are thousands of "average" servicemen, but there are still GOOD jobs with GOOD salaries waiting for men with sound technical training—men who realize that a pencil can be as important as a screw driver.

YOU CAN'T "BLUFF" YOUR WAY

Employers can afford to be "choosy" if you fail to satisfy. There's always ANOTHER man to take YOUR place. If you want to advance in Service work you must have the necessary TECHNICAL TRAINING to keep pace.

PROFESSIONAL SERVICEMEN

The RS1 courses in Advanced Radio Service and Public Address work are for men NOW in the field. We are not endeavoring to bring in new competition. You can start this complete training NOW—take up to 3 years to finish.

EASY TERMS YOU CAN AFFORD

These courses are practical right from the very first lesson, and will make you more money by saving you more time. Terms as low as \$5 monthly can be arranged. Write at once for details.

RADIO SERVICE INSTITUTE
 Subsidiary of C. R. E. I.
 14th and Park Road WASHINGTON, D. C.



FREE!

WRITE TODAY FOR THIS ILLUSTRATED BOOKLET ABOUT OUR COURSES AND YOUR FUTURE!

Send for Free Illustrated Booklet

RADIO SERVICE INSTITUTE Dept. RC-11
 3308 14th St. N. W., Washington, D. C.

Without obligation please send me Free Illustrated booklet "The Key to Successful Servicing."

Name

Address

City State

TECHNICIANS' DATA SERVICE

JOSEPH CALCATERRA

DIRECTOR

A special arrangement between RADIO-CRAFT magazine and the publishers of this literature, which permits bulk mailings to interested RADIO-CRAFT readers, eliminates the trouble and expense of writing to each individual organization represented in this department.

2. HAMMARLUND 1936 CATALOG. Contains 12 pages of specifications, illustrations and prices on the new line of Hammarlund variable, mid-gate, band-spread and adjustable condensers; trimming and padding condensers; R.F. and I.F. transformers, coils and coil forms; sockets, shields, chokes and miscellaneous parts of ultra-short-wave, short-wave and broadcast operation.

4. THE "COMET PRO" SHORT-WAVE SUPERHETERODYNES. Describes the outstanding features of the standard and crystal-type Hammarlund "Comet Pro" short-wave superheterodynes designed to meet the exacting demands of professional operators and advanced amateurs for a 15 to 250 meter code and phone receiver, but which can be adapted by anyone for laboratory, newspaper, police, airport and steamship use.

5. ELECTRAD 1936 VOLUME CONTROL AND RESISTOR CATALOG. Contains 12 pages of data on Electrad standard and replacement volume controls. Truvolt adjustable resistors, vitreous wire-wound fixed and adjustable resistors and voltage dividers, precision wire-wound non inductive resistors, center-tapped filament resistors, high-quality attenuators, power (50- and 150-watt) rheostats and other Electrad resistor specialties.

57. RIBBON MICROPHONES AND HOW TO USE THEM. Describes the principles and operating characteristics of the Amperite velocity microphones. Also gives a diagram of an excellent humless A.C. and battery-operated preamplifier.

59. THE EVOLUTION OF TUBE TESTING. This interesting booklet, published by the Supreme Instruments Corp., traces the development of tube testing equipment and gives a complete technical description, with wiring diagram and discussion of the technical points involved in the design and use of the Model 89 Supreme Radio Tester for testing all tubes, and also paper and electrolytic capacitors.

65. NEW 1936 LINE OF SUPREME TESTING INSTRUMENTS. This 16-page catalog gives complete information on the entire Supreme line of testing instruments, including the Model 385 Automatic Tube Tester and Analyzer, the Model 339 DeLuxe and Standard Analyzers, and other standard Tube Testers, Set and P.A. Analyzers and Signal Generators. Complete details of the Supreme Easy Payment Plan for purchasing testing equipment on the installment plan are given.

67. PRACTICAL MECHANICS OF RADIO SERVICE. Information, including cost, features and outline of lessons of the Frank L. Sprayberry course in Radio Servicing, and list of Sprayberry Data Sheets for modernizing old radio equipment.

69. YOUR FUTURE IN RADIO. With the development of Radio into many specialized fields, it has become increasingly important for anyone considering radio as a lifework, to investigate the opportunities offered in the various fields for a man of his particular qualifications. These opportunities are described in an interesting 32-page book, "Your Future in Radio" published by the Sprayberry Academy of Radio. It also gives complete information on the new Sprayberry Course in Radio Service Engineering which includes all standard equipment and supplies for the practical work required in mastering the course and going into business.

73. HOW TO ELIMINATE RADIO INTERFERENCE. A handy folder which gives very complete information on how to determine and locate the sources of radio noise by means of the Sprague Interference Analyzer. A description of the analyzer and method of using it is included, together with data on how to eliminate interference of various kinds once the source is located.

74. SPRAGUE 1936 ELECTROLYTIC AND PAPER CONDENSER CATALOG. Gives specifications, with list and net prices on a complete line of wet and dry electrolytic, and paper condensers made by the Sprague Products Co. for radio Service Men, set builders, experimenters and engineers. Information on the Sprague Capacity Indicator, for making capacity tests on condensers and in servicing receivers, is included.

75. SPRAGUE TEL-U-HOW CONDENSER GUIDE. A valuable chart, compiled by the Sprague Prod-

Radio-Craft Technicians' Data Service
 99 Hudson Street,
 New York City, N. Y. RC-1136

Please send to me, without charge or obligation, the catalog, booklets, etc. the numbers of which I have circled below.

- 2 4 5 57 59 62 65 67
- 69 73 74 75 76

My radio connection is checked below:

- Service Man operating own business.
- Service Man for manufacturer.
- Service Man for jobber.
- Service Man for dealer.
- Service Man for servicing company.
- Dealer.
- Jobber.
- Experimenter.
- Professional Set Builder.
- Amateur Set Builder.
- Short Wave Work.
- Licensed Amateur.
- Station Operator.
- Radio Engineer.
- Laboratory Technician.
- Public Address Worker.
- Manufacturer's Executive.
- Student.
-

I am a:
 Subscriber Newsstand reader
 I buy approximately.....of radio material a month. (Please answer without exaggeration or not at all.)

Name

Address

City State.....
 (Please print name and address)

Avoid delay. The catalogs and booklets listed are now in stock and will be sent promptly as long as the supply lasts. Please use this coupon in ordering. The use of a letter causes delay.

ucts Co. which tells the proper types, capacity values and voltages of condensers required in the various circuits of radio receivers and amplifiers, and how to locate radio troubles due to defective condensers. Includes data on condenser calculations.

76. FACTS YOU SHOULD KNOW ABOUT CONDENSERS. A folder, prepared by the Sprague Products Co., which explains the importance of various characteristics of condensers, such as power-factor, leakage, capacity and voltage in determining the efficiency or suitability of a given condenser to provide maximum filtering and safety in operation.

INTERNATIONAL RADIO REVIEW

(Continued from page 273)

the tube noise to a minimum as well as increasing the input impedance of the tube tremendously compared to tubes used for amplifying and detecting purposes.

The tube is a tetrode, having a control-grid and a screen-grid, and is connected in the space-charge manner, that is, with the control-grid and screen-grid "reversed" (as regards the voltage gradient).

Two circuits for using the electronometer tube, V1, for minute current measurements are shown in Figs. 3 A and B. The appearance of the tube can be seen in Fig. B.

AN UNUSUAL PORTABLE RADIO CASE

THE FRENCH radio magazine *Toute La Radio* (Paris) recently showed the portable radio set which is reproduced in Fig. C

In this set, the speaker is mounted in the side of the case, with a hinged door opening out, thus producing a sort of "horn" to assist in projecting the sound.

Please Say That You Saw It in RADIO-CRAFT

NEWEST TUBES

(Continued from page 271)

base. Although it has the same amplification factor as the types 6C5 and 6C5G, the mutual conductance has been substantially increased with corresponding reduction in the plate impedance. Also, the output capacity is approximately 1/3 that of the 6C5 so that the 6J5G is especially applicable to ultra-high frequency work. With the above exceptions, this tube parallels the characteristics of the 76, 37 and 6C5 tubes.

6J5G Characteristics

Heater Voltage A.C. or D.C.	6.3 V.
Heater Current	0.3- A.
Direct Interelectrode Capacities	
Grid-to-Plate	3.4 mmf.
Input	3.8 mmf.
Output	3.3 mmf.
Class A Amplifier	
Heater Voltage	6.3 V.
Plate Voltage	250 V.
Control-Grid Voltage	-8 V.
Plate Current	9.0 ma.
Plate Resistance	7,700 ohms (app.)
Mutual Conductance	2,600 mmhos (app.)
Amplification Factor	20

6K5G High-Mu Triode. The characteristics of this new Sylvania tube are similar to the 6Q7G, with the exception that the mutual conductance has been increased, with a corresponding reduction in the plate impedance.

The amplification factor of 70 is somewhat lower than that of the 6F5 or the triode section of the type 75 but this lower value allows higher signal voltages to be handled before the grid reaches the sector of grid current. The value of control-grid bias is, therefore, less critical than the other tubes mentioned.

The 6K5G operated with a supply voltage of 250 and a plate load resistance of 0.1-meg. to 0.25-meg. should have a control-grid bias of 2.5 V. When operated with 100 V. on the plate and a load of 50,000 to 0.1-meg. the grid bias should be about 1.4 V.

6N7G Characteristics

Heater Voltage A.C. or D.C.	6.3 V.
Heater Current	0.3- A.
Direct Interelectrode Capacities	
Grid-to-Plate	2.0 mmf.
Input	2.4 mmf.
Output	3.6 mmf.
Class A Amplifier	
Heater Voltage	6.3 6.3 V.
Plate Voltage	100 250 V.
Control-Grid Voltage*	-1.5 -3 V.
Plate Current*	0.35- 1.1 ma.
Plate Resistance	78,000 50,000 ohms (app.)
Mutual Conductance	900 1,100 mmhos (app.)
Amplification Factor	70 70

*These are rating values only and not operating points with coupling resistor.

6L6G Beam Power Tube. The beam power tube which was described in the July 1936 issue of *Radio-Craft* has been duplicated in a glass-envelope tube by Raytheon. The glass equivalent has the same rated characteristics as its metal cousin, and is equipped with the octal-style socket.

Dual-Triode 6N7 and 6N7G Class-B Power Amplifier. This tube is the octal equivalent of the 6A6—a glass B twin-triode output tube. The characteristics of the 6A6 have been published before, so they will not be repeated here.

The tube can be used for class A operation by connecting the elements of the two triodes in parallel. In this way, it can be used as a driver for a class B stage using a second 6N7 tube.

REMOVAL NOTICE

Increased sales of over 300 per cent for the current year over previous years has made it necessary for the Cornell-Dubilier Corp. to move the entire plant from its former location in New York to larger quarters in South Plainfield, N. J.

The large increase in sales within the past few years first made it necessary to add several additional buildings to the plant—but the company has now outgrown these facilities thus necessitating the move to New Jersey.

This Great Book Brings You RADIO'S GREATEST VALUES

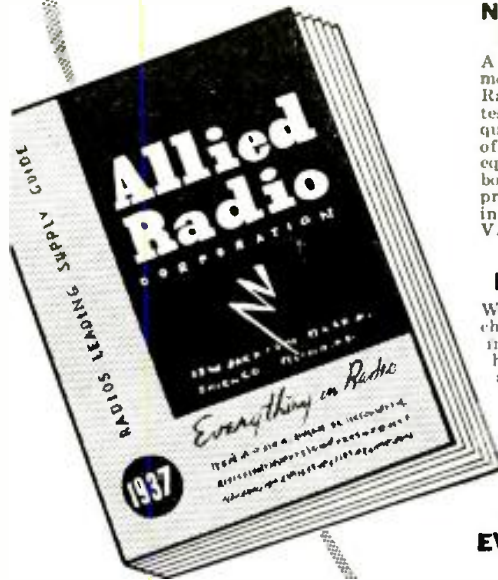

NEW 1937 ALLIED RADIO CATALOG RADIO'S LEADING SUPPLY GUIDE

A new book!—a complete book!—a time-saving, money-saving book!—that's the new 1937 ALLIED Radio Catalog! 152 value-packed pages—1,000 tested and approved parts—hundreds of high quality, low-priced sets and kits—complete lines of the newest in Amateur, Service, and P.A. equipment—page after page of the latest tools, books, etc.—Everything in Radio at the lowest prices! You don't have to look any further; here, in one great book, are listed RADIO'S GREATEST VALUES.

COMPLETE STOCKS—FASTER SERVICE—LOWER PRICES

We carry complete stocks of Radio's choicest merchandise on hand at all times. No delays, no inconveniences—no matter what you need, we have it—when you want it. ALLIED'S highly specialized organization fills, checks, packs and ships your order speedily and accurately. Our tremendous resources, our vast purchasing power, enable us to buy for less and pass the resulting savings on to you. Thousands of radio Amateurs, Dealers, Servicemen, Experimenters and Sound-men order from ALLIED regularly because they know they save time and money on every order.

EVERY ITEM TESTED AND APPROVED—BY RADIO EXPERTS

The new 1937 ALLIED Catalog brings you the benefits of world-wide search and research by skilled radio buyers, technicians, sound engineers, licensed Amateurs—men expert in every field in Radio. We carefully check every item for quality, performance and price. Our wide experience is your protection—your assurance of high quality and lowest prices. Our technical staff is at your service in other ways, too—to recommend replacement parts, to furnish parts lists for kits, to check P.A. specifications—to give you friendly, expert advice on every conceivable problem, without obligation. That's why ALLIED is known everywhere as "Radio's most Reliable Supply House."

No matter what your radio interest is, you need the new 1937 ALLIED Radio Catalog! If you don't have a copy of this great book send the coupon now; it's FREE!

EVERYTHING IN RADIO—AT LOWEST PRICES

FOR AMATEURS—A tremendous assortment of transmitters, receivers, and transceivers for every requirement.

FOR SET-BUILDERS—Dozens of new kits—metal tube DX'er, Super-Gainer, 0-volt all-wave set, 5-meter transceiver and many others.

FOR SERVICE MEN—Newest tube checkers, set testers, analyzers, colligrads, meters. Thousands of replacement parts, tools, books.

FOR SOUND-MEN—Latest P.A. equipment, 8-60 watt; permanent inobile and portable, for 110 volts AC, 6 volts DC, and universal operation.

FOR DEALERS—Complete service equipment—38 astounding new radios from 7 to 19 tubes, as low as \$8.15; 6 volt, 32 volt, AC, AC/DC, battery and auto sets. Rusher units and Windblowers.



ALLIED RADIO CORPORATION
833 W. JACKSON BLVD. CHICAGO

ALLIED RADIO CORP., DEPT. 2-L
833 W. Jackson Blvd., Chicago, Ill.

Please send me FREE 1937 ALLIED RADIO CATALOG

NAME

ADDRESS

CITY STATE

TRIAD

THE QUALITY NAME IN RADIO TUBES

TRIAD MANUFACTURING CO., INC. PAWTUCKET, R. I.

Do you still need one or more of the GERNSBACH RADIO SERVICE MANUALS to complete your files? If so, turn to page 260 of this issue for details.

Please Say That You Saw It in RADIO-CRAFT

Barcus-Lansing BASS BOOSTER

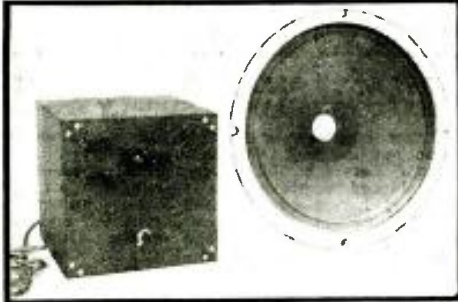

● Startling improvement in sound quality—Get concert hall performance from your own radio by simply adding a Barcus-Lansing BASS BOOSTER—Gives same depth of tone and the rich resonance of bass notes actually heard in the concert hall.

● The BASS BOOSTER consists of a low pass filter which removes frequencies above 70 cycles, a 2-stage high gain amplifier and a Lansing 12-in. No. 212 Speaker—coordinated to produce a new achievement in sound reproduction. This unit may also be used as a phonograph amplifier by throwing operating switch.

● Complete kit of parts including 7 in. by 7 in. by 7 in. black crackle finish cabinet and speaker. List price \$30.00 (less tubes).

Write for detailed description or ask your local dealer.

LANSING Manufacturing Co.
6900 McKinley Ave.
LOS ANGELES, CALIF.

BARGAIN BULLETIN
SAVE MONEY ON EVERYTHING YOU BUY!

SPORTING GOODS
WATCHES-CLOCKS
TYPEWRITERS
OPTICAL GOODS
CAMERAS-NOVELTIES

RADIO SETS AND REPLACEMENT PARTS

NEW FALL CATALOG JUST OUT!

SEND FOR YOUR FREE COPY TODAY!

Buy efficiently, economically, safely! Hundreds of high quality items—leading lines and standard brands—at prices amazingly low! Real bargains! Square dealing! Write today for your big, free copy of this new catalog hot off the press.

RADIO CIRCULAR CO., INC.
915 BROADWAY Dept. RC NEW YORK, N. Y.

A KEY TO RADIO AS A VOCATION

(Continued from page 275)

the radio industry would offer great possibilities for women, because today the radio set is just a common piece of household equipment. Knowing that women are credited with spending 80 cents out of every dollar, one would expect to find women employed in research laboratories to give radio sets the "woman's touch."

It is true that there are at present thousands of women employed on the assembly lines of American tube and set factories, but no case is known to the author where a woman has an important position in a radio laboratory. There are, of course, a few women radio operators known, and some women designers who cooperate as free-lancers with radio cabinet factories, but this seems to be all that can be said at present about women in the radio industry.

It is of interest that women broke into the radio profession as radio operators, because the job of radio operator is not only an interesting, but also a responsible one.

CAREERS FOR THE MEN-FOLK

There are also a great many young men who are interested in radio operating as a career, despite the fact that this profession is not as highly paid as many believe (the recent strikes of radio operators indicate this clearly). However, there must be something attractive in this career because the U. S. Census counts 5,000 employed in the various land stations, and aboard American ships.

About 2,300 men have found employment as technicians in connection with the American broadcasting stations. What these men earn, and how their incomes compare with other employees working in the broadcast industry, are figures that have recently been compiled in the form of a regular census by Mr. C. H. Sandage, of the U. S. Bureau of Commerce.

The census is as yet not completed because of the 564 broadcasting stations covered by the census, only 561 cooperated with the Bureau. These stations employ 14,561 persons with an annual payroll of \$26,911,392.

The average income of broadcast technicians varies according to the location, but before we give the facts about the higher salaries paid in certain parts of the country, we will present some surprising facts. We will then find that the glamorous fame which surrounds the radio artists and radio announcers is, as far as salaries are concerned, absolutely unjustified. The average income of a radio technician, doing his duty in plain overalls, exceeds by far the average income of the announcers who speak daily to millions.

According to the U. S. Census, an announcer gets on the average \$29 weekly, but the average income of a station technician is \$35. (See Fig. 4A.) The artists employed by the broadcasting stations receive, on the average, a weekly income amounting to \$41. The income of the nationally-known artists, who are employed mostly by advertisers ("commercial sponsors") are of course not included in this compilation, since they are paid directly by the advertisers. Additional details which will do away with many of the tales about the salaries paid by the stations are given in Table I.

There is one exception to be considered, these figures do not concern the weekly average income of the persons employed by the great networks. Network technicians receive on the average \$60 weekly, and only network announcers who have an average income of \$91 exceed with their salary the income of the technicians.

WHAT REGIONS PAY TECHNICIANS BEST?

And now to the regional tips in regard to the best salaries paid. To make the story simple, all facts concerning this very important question have been combined into a map (see Fig. 3) which shows the average salaries paid to radio technicians in various parts of the country.

The best salaries, we find, are paid in the Middle Atlantic States, and amount to \$40. A careful study of the map under consideration showing the different living expenses in each section may provide some interesting facts for job seekers.

Is it possible, then, that the "big money" may lie elsewhere than in radio, *per se*? Let us look further into the story.

POWER COMPANIES ARE THE BIG MONEY MAKERS

In a series of 8 broadcasts during February, 1936, the Columbia Broadcast System presented interviews with 8 Americans having widely different points of view and interest, and asked them for their opinions concerning some of today's important problems in broadcast control. Among the persons interviewed was Dr. Orestes Caldwell, one of the original members of the Federal Radio Commission. Among other things, concerning American Broadcasting, he stated the following interesting facts: "The big money in broadcasting goes to the electric light companies. In fact, they collect 2 dollars for every dollar earned by the artists, the broadcasting stations and the networks, combined." (See Fig. 4B).

"For the operation of radio sets alone, the utilities companies collect about 150 million dollars yearly. This is about twice the entire amount that it takes to operate all the broadcast stations, the chains and the networks in the U. S." Dr. Caldwell suggested that the power companies should pay the entire cost for the present superb programs, and they would still enjoy a net increase in income of about 70 million dollars per year.

In connection with the interview quoted above, Dr. Caldwell, who is one of the leading authorities on broadcasting, made the following pithy remarks about the future of the radio field, which will show, much better than all our detailed summaries could do, what one might reasonably expect to find upon going into the radio industry as a career.

He said: "This thing we call 'radio' is just beginning. With Broadcasting and Communication thus far we have just opened the first page or two of the radio book. The big chapters are all yet to come." (See Fig. 4C).

"Ahead of us is the vast empire of the Short (Continued on page 299)

TABLE I
Analysis of Employment and Weekly Pay Rolls—(Broadcast Stations only)

Classification	All Employees (but not artists, etc., supplied by advertisers)		Full-Time Employees		Part-Time Employees			
	Number	Pay-Roll	Number	Pay-Roll		Number	Pay-Roll	
				Total	Average		Total	Average
Total: 561 stations	13,139	\$429,401	10,287	\$388,068	\$38.00	2,852	\$41,333	\$15.00
Executives	476	\$43,537	437	\$42,079	\$96.00	39	\$1,458	\$37.00
Supervisors	703	\$43,197	690	\$42,825	\$62.00	13	\$372	\$29.00
Office and Clerical	2,149	\$50,552	2,035	\$49,349	\$24.00	114	\$1,203	\$11.00
Station Technicians	2,451	\$84,803	2,360	\$83,609	\$35.00	91	\$1,194	\$13.00
Station Talent								
Artists	4,169	\$114,270	1,999	\$82,026	\$41.00	2,170	\$32,244	\$15.00
Announcers	1,695	\$46,412	1,556	\$45,027	\$29.00	139	\$1,385	\$10.00
Others*	1,496	\$46,630	1,210	\$43,153	\$36.00	286	\$3,477	\$12.00

*Includes employees not otherwise classified. Persons performing a variety of functions where no set function requires a major portion of employee's time, as well as continuity writers and salesmen are included here.

Please Say That You Saw It in RADIO-CRAFT

THE FAST-MOVING RADIO FIELD

(Continued from page 276)

the "enemies" that must be overcome in certain diseases before you can start on the road to recovery. The inductotherm creates an artificial fever—a high temperature—in your body, and that high fever does the trick. The Radio Knife is one of the latest contributions made by science to the work of the surgeon. With this remarkable tool the surgeon is able to cut deftly, bloodlessly, freed from any possibility of infection. This means a clean, quick-healing wound.

THE "ELECTRIC EYE"

No contributions that radio makes to mankind hold greater appeal to the imagination than those which make life easier and happier for the afflicted and helpless. In New York City there is a young boy, practically helpless from paralysis, who, thanks to the interest and help of his doctor, is able to turn his radio set off and on by merely nodding his head. He is able to do it with the aid of the photoelectric cell, which permits him by a nod of his head to turn on his set when he wants to listen to any particular program, and to turn it off when he wants to rest. Then again, the scientist adapts the photoelectric cell to the job of providing a means whereby the sightless can make their way in safety and with confidence. The demonstration of this boon for the blind is one of the most interesting in the series of applications of electricity to unusual purposes.

In printing and in publishing the "electric eye" (or photoelectric cell) bids fair to revolutionize present processes. A newspaper editor wants a half-tone cut. His secretary can make the half-tone right in his office and have the finished cut back on his desk before the editor has had time to write the corresponding caption, saving several hours of time and the 179 manual processes required in present half-tone making. Beautiful 3-color plates are now made in half an hour instead of 3 days; and the cost of such photoelectric engravings is 1/20 of that by the old-fashioned method. "Electric eyes" now match colors of paper and inks far more accurately than any human eye could do. They count logs entering paper mills; they control the thickness and determine the degree of "fuzz" of paper being produced. They detect breaks in the great rolls of paper going through huge printing presses and instantly stop the machines, saving tremendous expense and damage.

Schools and factories now have their electric lights automatically turned on whenever a passing storm or early dusk makes it desirable to have more illumination. In restaurants, waiters laden with trays walk directly into closed doors, and presto, the doors jump open, waved aside by the waiters' shadows. Many hotels and restaurants are now using these "magic" doors.

The photoelectric cell has already proved its ability as an Automatic Fire Extinguisher. A hose nozzle equipped with an "electric eye" can calmly sway back and forth searching out a fire. When it sights a flame it instantly stops, turns on the water and puts out the fire. Then the automatic fireman turns off the water and continues its search for more fires!

The scientist also has always known that Old Sol, pouring his rays down on this earth of ours is a source of energy that man some day will probably succeed in harnessing to do something else than give us a tan or sunburn. And right now in this day and age the scientist is beginning to capture some of that abundant energy with which he is so prodigal, and turn it to use. The Sun Motor, operated by electrical energy supplied by light furnished by the sun, is already a reality. Possibly our successor on earth a hundred years from now will marvel that we found anything so remarkable in a sun motor, but today it is a wonderful thing—a new thing, the first step toward the realization of the everyday practical utilization of the incalculable energy that pours down from the sky.

FACSIMILE AND TELEVISION

Then there is talk of radio facsimile—newspapers and magazines printed by radio in homes everywhere. This new development will bring printed pages into homes and remote places with the speed of light. In fact, a metropolitan newspaper, complete with headlines, display advertising, cartoons, all of them typographically up to the minute, can now be laid down at the most distant fireside without the aid of physical transportation facilities.

Television is rapidly reaching the stage where it will not be long before it will be used in the home. Plans for an independent nation-wide television network have been discussed in New York and Washington during recent weeks. It is proposed to set up 15 20-kw. key stations at \$100,000, each; 40 local 5-kw. stations at \$25,000, each, and 250 beam relay stations having a 25-mile range for interconnecting the network stations. The initial cost is estimated at 4 million dollars, with an operating cost of 1 million dollars!

All of this shows that radio's usefulness is constantly broadening and that numerous attractive opportunities exist today in the radio field. Broadcasting stations must have capable men for installing, maintaining and repairing their television equipment. The sound picture industry requires thoroughly-trained, highly-skilled technicians for the maintenance and repair of sound-picture apparatus. In fact, the trend of radio development offers unlimited possibilities. And whatever phase of radio one decides to specialize in as a career requires a good general training in electrical and radio technique.

To train young men for the broad field of radio a school system with which the writer is connected has set up in addition to its regular Radio Operating and Servicing courses a new day and evening training course of instruction in Applied Electronics which will appeal to those individuals interested in radio. The course of instruction in this subject imparts a working knowledge of the fundamentals of the vacuum tube, in theory and in practice. It teaches the basic things regarding electrical theory, radio physics, and mathematics needed to succeed in radio, and it ties in these studies with practical work in radio servicing, sound pictures, electronic tube circuits and systems, electronics in industrial applications, therapeutics as applied to high frequencies in medicine, and many other applications.

This article has been prepared from data supplied by courtesy of New York Y.M.C.A. Schools.

A KEY TO RADIO AS A VOCATION

(Continued from page 298)

Waves, and the Ultra-Short Waves with their hundreds of thousands of channels. Ahead of us, too, is Facsimile—the delivery out of the radio set, of a little printed newspaper right in your home. And Television is on the way. And there's Wired Broadcasting over the electric wires, and over the telephone wires, both new in experimental operation over considerable areas.

"We'll have plenty of broadcasting of one kind or other, to give all the free speech that anyone wants."

Although these sidetracks in the application of radio are often of considerable commercial value, if we compare them with the business possibilities in the broadcast field still waiting to be utilized, the comparison will be in favor of the broadcast field.

STATISTICS UP-TO-DATE

There are about 22,500,000 passenger cars registered in the U. S., but only 2,400,000 cars are as yet equipped with receivers (see Fig. 4D). The American radio industry sold, during 1935, 350,000 battery-operated receivers, but according to a survey made by the Rural Electrification Administration, 80 per cent of all farms are still without radio (see Fig. 4E). According to statistics published by the Joint Committee On Radio Research, there are at present 25,000,000 radio receivers in use in the U. S. More than 50 per cent of these are quite obsolete and the number, which should be replaced by new models, grows each year. The total number of sets manufactured in 1935 was about 5,350,000, but about 67.9 per cent of the receivers sold to the American public were replacement sales. Estimates of the total production for 1936 give as a production mark, the large number—6,000,000 radio receivers.

Obsolescence in radio sets is a kind of "life insurance" for the radio industry, since each day more sets become old fashioned, and each day thousands of new families become enthusiastic radio listeners.

Radio is still a young industry offering great possibilities. Take your share out of the radio bag.

YOURS FOR THE ASKING!



The latest Sylvania service booklet is off the press. Send for your FREE copy NOW!

Have you an auto radio installation or servicing business? Then you can't afford to be without this latest Sylvania Service Manual. This handy little booklet is chock-full of valuable information compiled by one of the most expert engineering research staffs in the business. And it's written in your language!

Here are just a few of the important subjects covered: Elimination of motor interference for every make of 1936 car . . . Tube complement chart for practically all models of automobile radio sets, with I. F. peak frequencies . . . Set and Antenna installation hints . . . Power Supply hints, etc. These and hundreds of other problems you will meet in auto-radio installation and servicing are covered in this amazing book. If this book cost a dollar, you'd pay it willingly. *But it doesn't cost a cent!* It's yours absolutely free. All you have to do is fill out the coupon below and send it to us. You'll receive your free copy in a few days.

Hygrade Sylvania Corporation, Makers of Sylvania Radio Tubes and Hygrade Lamps. Factories at Emporium, Pa., Salem, Mass., and St. Mary's, Pa.

SYLVANIA

The Set Tested-Radio Tubes

HYGRADE SYLVANIA CORP. RC-116
EMPORIUM, PA.

Please send without obligation your new service book, "Auto-Radio Installation and Servicing".

Experimenter Amateur Call
 Serviceman Employed by dealer Independent

Member Service Organization

Name

Address

City

State

Name of jobber

Address

Please Say That You Saw It in RADIO-CRAFT

RADIO AND PUBLIC ADDRESS AT THE BERLIN OLYMPICS

(Continued from page 268)



**OL'MAN CENTRALAB
'TAKES IT' EITHER WAY**

blistering heat, or excessive humidity . . . it's all the same to a CENTRALAB Control . . . Millions of these Controls are "standing up" under unbelievably severe conditions . . . so the next time a control goes "haywire" change to CENTRALAB . . . and play safe.



Centralab
MILWAUKEE WIS.
BRITISH CENTRALAB, LTD.
Centerbury Rd., Kilburn
London N.W. 6, England
CENTRALAB
68-70 Rue Amelot
Paris, France

played broadcasts to America via phonograph records to compensate for the time difference and diurnal conditions. Also available were 20 transmitting cars with complete recording outfits, several portable short-wave microphones, and a radio-equipped boat for special short-wave reports of aquatic events. Coordinating the services of more than 100 microphone outlets and the several hundred loudspeakers, was a master switchboard. Although not quite as successful as anticipated, television transmission and reception of some of the events lent novelty to the Olympics.

Referring to the photographic illustrations, the views are described in detail as follows: (1) This master switchboard controlled over 100 microphone outlets of the huge public arena P.A. system, also the hundreds of loudspeakers, the more than 35 foreign broadcast channels, the German broadcast channels, and the spot phonograph recordings. (2) To overcome echo effects the sound system described in principle in the July, 1936, issue of *Radio-Craft*, page 9, was utilized. Improved "double umbrella" reproducers mounted on poles were used in profusion. Each of these Telefunken "umbrella" reproducers comprised 2 separate "umbrellas," as shown, with 5 loudspeaker units in each. As shown at upper-right in illustration No. 2, wings and deflectors separate each of the 5 units and properly direct the sound waves; as the insert at lower-left shows, each of the 5 units is weather-proofed and sound-baffled by means of bags. (3) The knapsack portable microphone here shown was used for directing the installation of the P.A. system, etc., and for spot broadcasts to nearby pick-up points. (4) The extensive short-wave antenna array installed at Zeesen especially for the Olympic Games that permitted the astonishing accomplishment of 100 simultaneous poly-lingual broadcasts is shown. (5) A Zworykin iconoscope tube was built into this television image pick-up camera, used at the Games. (6) A newly-designed German crystal micro-

phone was used in the motor launch short-wave transmitter that followed the crews entered in the Olympic regatta. The microphone with its preamplifier is here shown wrapped in sponge rubber. This concludes the detailed descriptions of the views.

The Assembly Ground was provided with microphone facilities for 10 "radio reporters"—plus facilities for 5 reporters on each platform of both the 100-ft. Outlook Towers at one end of the grounds. Similar facilities were provided for 20 eyewitness reports at the Swimming Stadium; 16 at Deutschland Hall, in close proximity to two Boxing Rings; 15 more at the Hockey Stadium; 8 at the Grunau Rowing Fixtures; 6 at each of the Football and Handball Courts at Berlin Sports Grounds—3 spot phonograph recording units were provided at the Marksman-ship Competition, due to the difficulty of providing fixed connections, and a similar arrangement was followed at the Doberitz Military Exercise Ground; facilities were provided for 3 radio reporters at the Art Exhibition on the Kaiserdam; 10 for the Fuhrer and Reich Chancellor receptions; and 10 each at the Pergamen Museum, at Berlin University for the opening session of the International Olympia Committee, at Tempelhof Aerodrome for the fancy flying championships, at the Berliner Lustgarten torchlight relay race, for the yacht races in the Bay of Kiel, at the Baseball Field, the German Sports Forum House, at the Dietrich-Eckhardt Open Air Theatre where choric games and musical items were held; and 10 at the Cycling Track.

In this manner broadcasting facilities were made available to the hundreds of eyewitness reporters of more than 35 countries, outside of Germany.

Even the Berlin Railroad Station was equipped with directional and non-directional loudspeakers for regulating traffic and to keep visitors posted concerning the progress of the various contests.

THE BUSINESS OF "RADIO PLASTICS"

(Continued from page 276)

when the first commercially-manufactured receiving sets for the home made their debut.

Many of these sets were of the type where the component parts were assembled on a board. Practically all of these sets used the new insulation, in either its molded or laminated form. At the same time amateurs were taxing the capacity of the industry for headphones, tube sockets, coil forms and numerous other parts made of these insulation materials for their own "hook ups." Molded dials 3 ins. in dia. were selling for over a dollar apiece!

With the demand far exceeding the supply, radio started to grow up. About 1924, sets in wooden cabinets appeared on the market, adding hand-somely finished front panels of laminated insulation to the already established uses of the material. Headsets gave way to horns, some of which were molded. A host of new uses developed for these two insulating materials—static eliminators, lightning arresters and inside aerial frames.

Almost overnight radio became an industry of national importance. In 1924, 1,105 exceedingly small-powered stations crowded the narrow American broadcast band of 200 to 550 meters. In 2 years this "howling, whistling era" gave way to organized broadcasting. The number of stations was reduced to 533 in the broadcast band—and many began to operate on higher power. To match this progress the manufacturer of the receiving set brought forth electrically-operated receivers. The "furniture period" followed almost immediately, with consoles, highboys and lowboys concealing all operating parts except the dial and knobs. With these successive steps of refinement in receiving mechanism and radio cabinet design, new uses for molded and laminated insulating materials were developed. Laminated translucent materials for illuminated dials, base plates for the new metal tubes, tuning knobs of colored materials to match wood cabinets, and all molded cabinets for the smaller-sized sets are typical of improvements within the past 2 years.

Short-wave broadcasting has opened up to radio enthusiasts new and exciting territories for exploration, and radically new types of molded insulating materials have been and are being developed to meet these new problems in transmission and reception, and the future requirements of television and facsimile broadcasting. Among these materials is a special "low loss" molding material which provides the important property of low power factor at radio and audio frequencies (at A.F. it is 1.6 per cent, at R.F. it is 0.75- per cent; the dielectric constant is 5.2).

One of the most interesting recent developments in this ever-growing industry of communication is a new bullet-shaped microphone (described in this issue of *Radio-Craft*:—Editor).

Some very good-looking sets housed in all-bakelite molded cabinets have recently been introduced. (See heading illustration.)

These insulating materials are employed in radio set construction in so many different materials—molded, laminated, cast resinoid, and even resins used in quick-drying varnishes, as well as the baking type enamels and varnishes for electrical insulation purposes.

Our Information Bureau will gladly supply manufacturers' names and addresses of any items mentioned in *Radio-Craft*. Please enclose stamped return envelope.

EXPERIMENTERS

The December issue of *Radio-Craft* is especially written for YOU. Many subjects of vital interest to all radio men—experimenters, Service Men, P.A. specialists, etc., will be found in this unusual issue of *Radio's* Livest Magazine—*Radio-Craft*.

2 Channel Hi-Gain Input \$19.95 2 Speaker 16-Watt Output



4 Stage dual channel Amplifier.
Hi-gain stage 120 DB.
for crystal or velocity mike. Low Gain stage 90 DB. for pickup or tuner. Perfect mixing and fading by individual controls. Frequency response 40—10,000 cycles ± 2Db. Continuous type tone control. Field supply 12 watts for 2 speakers. Throwover switch for 4 or 2 speaker operation. Tapped output transformer built-in. 16 watt output, 20 watt peak.

Tubes, 1—75, 2—6AG's, 2—6B5's push pull, 1—5Z3. Oven-baked crystalline finish with ventilated cover, overall 8" deep 14" long 9" high. Ruby Lite and Automatic Cutout switch on rack. **\$19.95**

Set of 6 tubes \$5.95, Magnavox 12" spks. \$4.45 ea. Rola 10" Spks. \$3.45 ea.
Universal Velocity or Shure Crystal Mike . . . \$13.50
Shure Crystal Mike or Universal Velocity **\$13.50**

Write us for FREE service consultation on any particular P.A. problem. No charge.

THOR RADIO

167 GREENWICH ST. NEW YORK, N. Y.

Please Say That You Saw It in RADIO-CRAFT

THE BUSINESS OF "RADIO PLASTICS"

(Continued from page 276)

in use, the "phenol-formaldehyde" or "phenolic resins" are most commonly used for radio cabinets and parts. As the name implies, *phenol* and *formaldehyde* are the chief raw materials. The resin is produced by a chemical reaction between these two compounds in the presence of a "catalyst." The process is carried out in a reaction kettle to which heat is applied in order to start the reaction. Before the reaction is completed, a heavy fluid is drawn off which hardens as it cools. The material thus obtained is the resin used for molding. It is actually the product of an incomplete chemical reaction. This reaction is subsequently completed by the molding process, which produces the hard, infusible material we see in tube bases and other molded parts.

However before the resin may be molded, it must be mixed with a filler—generally wood flour, although other materials such as asbestos and canvas scraps are used for special purposes. The mixing operation is accomplished by breaking up the hardened resin and working it into the filler on warm mixing rolls. After it has been thoroughly mixed and cooled the batch is ground to a powder ready for molding. The various noddles and colors are obtained by adding suitable pigments and dyes, or combinations of them, to the mixture.

The molding process begins with loading the resin compound into heated molds. The general practice is to pre-form the resin compound in large presses to form "pills," or tablets. These pills, which are carefully made to an exact size and weight, are placed in the cavities of the molding presses. When the presses are loaded, the molds are closed as far as the pills in the cavities will permit, and then the heat is applied. When sufficient heat has been absorbed, the resin becomes plastic at a molding temperature of about 350°F. The pressure which is applied at the start of the process must be increased as the material becomes plastic, and with the increase in pressure the mold finally closes. The resin is held under heat and pressure until it has had time to "cure" or set. This curing is the completion of the chemical reaction which began when the phenol and formaldehyde combined to form the resin. When the compound is cured, it is hard and infusible and may be ejected from the press without cooling.

AN "ACORN"-TUBE BEAT-FREQUENCY OSCILLATOR

(Continued from page 278)

combined and fed into a self-biased type 955 detector which extracts the audio or difference frequency and rejects any R.F. present. The output from the detector is fed into the output amplifier which is a type 955 fixed-bias amplifier having the output control in the grid circuit and a statically shielded output transformer in the plate circuit. This transformer is designed to operate into center-tapped loads of 250, 500 and 5,000 ohms impedance.

The circuit design of this instrument is such that a high degree of stability together with low distortion is obtained.

This article has been prepared from data supplied by courtesy of RCA Manufacturing Co.

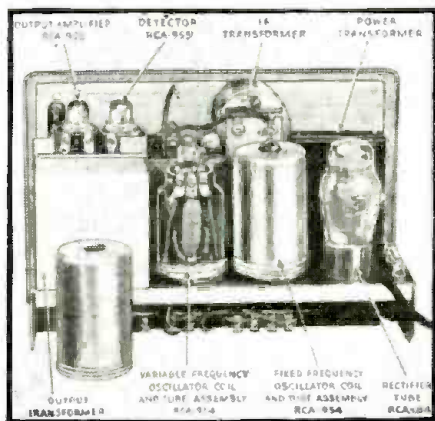

The chassis of the oscillator.

Now Ready - a new 2nd Edition



"The handy job data book"

Ghirardi's new greatly enlarged RADIO FIELD SERVICE DATA

NEARLY TWICE as big as the first edition—over 400 pages in all, with dozens of charts and diagrams! Now in loose-leaf form it's even handier for practical reference use in the shop or out on the job. Up to the minute in every last detail. Supplements twice a year (Jan. and June) keep it up to date and make it permanently indispensable in your work. Features listed at left are only a few of those contained. The I.F. and Case History data alone are worth many times the cost of the book. CLIP AND MAIL COUPON TODAY! Free Folder.

Complete with 1 Year's Supplements — \$2.50

Combination Offer

RADIO FIELD SERVICE DATA and MODERN RADIO SERVICING

Save money on this deal! Ghirardi's great MODERN RADIO SERVICING has been acclaimed for over a year as "the Serviceman's Book of Knowledge." Explains fully the 417 things every serviceman should know. Complete. Clear. Up-to-date. Over 1300 pp. 706 illus. \$4 by itself—

BOTH BOOKS \$6.00



MAIL TODAY!

RADIO & TECHNICAL PUBL. CO.

45 Astor Pl., New York, Dept. RC-116

Enclosed please find \$6 for Combination offer on both books, postpaid, including Jan. and June 1937 Supplements. (Foreign \$8.50.)

Enclosed please find \$2.50 for RADIO FIELD SERVICE DATA, postpaid, also including supplements. (Foreign \$3.)

NAME

ADDRESS

CITY

Money-back Guarantee!

LOW WHOLESALE PRICES



BIG FREE CATALOG

Over 10,000 items in this big catalog including radio receivers, nationally known radio parts and broadcasting equipment at low wholesale prices. A catalog of great value to dealers and servicemen. Write for your FREE copy today.

BURSTEIN-APPLEBEE CO.
1012-14 McGEE ST., KANSAS CITY, MO.

Please Say That You Saw It in RADIO-CRAFT

Pocket Volt-Ohmmeter

Pocket size—20 ounces. Meter set at easy reading angle. 3 direct reading scales 0 to 500 volts, 0 to 500,000 ohms. Voltage scale on outside arc of meter for greatest accuracy. Battery drain 1 ma. All ranges selected from master switch. Shipping weight 3 lbs. Shipped immediately on receipt of order.

9.80 NET



TRIUMPH MANUFACTURING COMPANY
4017 W. LAKE STREET CHICAGO, ILLINOIS

New! Auto-Top Aerial



U. S. Pat. 97447

THE common sense aerial for steel top automobiles. Puts the aerial OVER THE TOP where it belongs. Outstanding performance, plus keen streamlined appearance—highly polished aerial—semi-round—die formed like decorative body trim—mounted on top of rubber vacuum posts—carries center trim line of hood, windshield, and rear window right over top of car. Extremely efficient—not damaged by weather—works in rain, ice and snow anywhere, anytime. Steel car top shields against interference from ignition and lighting. Easy to install—shipped straight, no kinks—no holes to drill in top—easy on car finish. A fast seller—users like the smart appearance—greater volume—more distance—and reduced noise.

SOLD BY LEADING JOBBERS. LIST \$3.85
RADIO SERVICE MEN—If your jobber can't supply you send his name for **COMPLETE INFORMATION** and **SPECIAL INTRODUCTORY OFFER**. Write today. Be the first to show Auto-Top, the perfect auto aerial. Clean up before the others wake up.
WEDGE MANUFACTURING CO.
 2336 S. Michigan Avenue, Chicago



Professional Antenna for All-Wave Sets

Same type used on receivers in licensed stations in South Africa and South America.

Greatly increases DX performance, cuts down static, eliminates man-made interference, doubles short wave reception. Complete set includes: Double aerial, double lead-in wires, high-tension porcelain support and lead-in insulators, dual lightning arrestors, variable ratio matching transformer, complete instructions and installation diagram. Ask us for statements of performance from world-wide users.

Priced right; write today for your all-wave antenna kit.
PORCELAIN PRODUCTS, INC.
 Dept. 33 Findlay, Ohio

NOW READY! The OFFICIAL RADIO SERVICE HANDBOOK—order your copy today. Complete details on page 261 of this issue.

A SPECIAL A.F. AMPLIFIER FOR THE DX-ER

(Continued from page 277)

standard. The success of the system depends entirely upon the selection of constants for the 2 channels.

Automatic tone control results from biasing the "treble detector" by returning its diode-load resistor to a point more negative than the cathode (ground). Treble response increases with the increase of signal strength so that not only better tone is had from the stronger stations, but the rasping and shrill distortion accompanying fading in a receiver using A.V.C. is almost completely eliminated! A less important but noticeable effect is heard when tuning in a station. The signal is heard in subdued bass as the dial pointer nears the desired setting and treble is heard loudest when resonance is reached—which is the exact opposite of the usual noisy tuning.

Two aids to better tone are a part of the tuner circuit. One is a Hi-Fidelity snap switch, which broadens the selectivity of the first I.F. transformer when conditions make its use possible; the other is a 3-position, 2-section, Sensitivity or Clarifier switch. Its purpose is to prevent traces of distortion due to tube paralysis, or incorrect bias under various reception conditions, and to keep the receiver above noise level as much as possible. Position No. 1 is for use when a consistently powerful local overloads the set.

Position No. 2 is for general use. It connects the aerial to the primary of the first tuning coil and switches another bias resistor into the V2 and V3 circuits. This resistor is a 5,000-ohm rheostat on the chassis rear which is set for the prevailing noise level.

Position No. 3 gives the extreme sensitivity possible by lowering the bias voltages to a minimum.

Experiments are going forward to determine the constants for the circuit shown at Fig. 3B, wherein the high and low channels terminate out-of-phase and are mixed inductively in push-pull by a center-tapped A.F. choke, which feeds 2 resistance-capacity coupled push-pull stages.

- One Solar mica condenser, 0.001-mf., C17;
- Two Solar condensers, 0.05-mf., 200 V., C18, C19;
- One tuning condenser 3-gang, 365 mmf.;
- *One Antenna coil;
- *One R.F. coil;
- *One Oscillator coil, 175 kc.;
- *One variable coupling I.F. transformer. This may be an iron-core transformer with switch-type band expansion, 175 kc.;
- One straight I.F. transformer, 175 kc.;
- One diode I.F. transformer, 175 kc.;
- *One single-gang, 1-circuit, 1- to 6-point switch (sensitivity switch);
- Three 6-prong sockets;
- One 7-prong socket;
- One 5-prong socket;
- Five tube shields;
- Three Hygrade Sylvania type 6D6 tubes;
- One Hygrade Sylvania type 6A7 tube;
- One Hygrade Sylvania type 76 tube;

A. F. Amplifier

- Five Continental Carbon resistors, 0.1-meg., 1/2-W., R1, R2, R4, R18, R3;
 - One Cont. Carbon resistor, 0.5-meg., 1/2-W., R5;
 - Six Continental Carbon resistors, 0.5-meg., 1/2-W., R6, R7, R8, R9, R16, R19;
 - Two Continental Carbon resistors, 50,000 ohms, 1/2-W., R11, R17;
 - Three Continental Carbon resistors, 75,000 ohms, 1/2-W., R2, R10, R12;
 - Two Continental Carbon resistors, 7,500 ohms, 1/2-W., R13, R14;
 - One Cont. Carbon resistor, 3,000 ohms, R15;
 - Two Electrad potentiometers, 1 meg., VR1, VR2;
 - One Electrad potentiometer, 0.5-meg., VR3;
 - One Electrad poten. with switch, 0.25-meg., VR4;
 - Two Solar mica condensers, 100 mmf., C1, C2;
 - One Solar mica condenser, 0.001-mf., C3;
 - Five Continental Carbon condensers, 0.1-mf., 400 V., C4, C5, C6, C21, C22;
 - One Cont. Carbon condenser, 0.02-mf., 400 V., C7;
 - Two Solar mica condensers, 0.002-mf., C8, C9;
 - One Solar mica condenser, 50 mmf., C10;
 - One Cornell-Dubilier electrolytic condenser, 50 mf., 50 V., C11;
 - One Cornell-Dubilier condenser, 1 to 25 mf. (low enough capacity to avoid motorboating), 50 V., C12;
 - One Cont. Carbon condenser, 0.5-mf., 400 V., C13;
 - Two Cornell-Dubilier electrolytic condenser, 2 mf., 450 V., C14, C15;
 - One Cont. Carbon condenser, 0.25-mf., 400 V., C16;
 - Two Cornell-Dubilier electrolytic condensers, 8 mf., 600 V., C17, C18;
 - One Cornell-Dubilier electrolytic condenser, 16 mf., 450 V., C19;
 - One Continental Carbon condenser, 0.05-mf., 400 V., C20;
 - One power transformer supplying 750 V. C.-T., 120 ma., 5 V. at 3 A., and 6.3 V. at 6 A.;
 - One filter choke, 30 hy., 120 ma.;
 - One 12-in. speaker, 2,500-ohm field;
 - Two Burstein-Applebee tube shields to fit tubes;
 - Four Burstein-Applebee 6-prong sockets;
 - One Burstein-Applebee large 7-prong socket;
 - One Burstein-Applebee 4-prong socket;
 - One Burstein-Applebee 5-prong socket;
 - Two Hygrade Sylvania type 75 tubes;
 - One Hygrade Sylvania type 6A6 tube;
 - One Hygrade Sylvania type 76 tube;
 - Two Hygrade Sylvania type 6B5 tubes;
 - One Hygrade Sylvania type 5Z2 tube.
- *Names of manufacturers will be sent upon receipt of a stamped and self-addressed envelope.

LIST OF PARTS

- Tuner
- One Continental Carbon resistor, 400 ohms, 1/2-W., R1;
- Two Continental Carbon resistors, 800 ohms, 1/2-W., R2, R3;
- One Cont. Carbon resistor, 1,000 ohms, R4;
- One Cont. Carbon resistor, 600 ohms, R6;
- Two Cont. Carbon resistors, 50,000 ohms, R7, R18;
- Two Cont. Carbon resistors, 0.1-meg., R11, R12;
- One Continental Carbon resistor, 30,000 ohms, 1/2-W., R8;
- One Continental Carbon resistor, 30,000 ohms, 4 W., R9;
- One Continental Carbon resistor, 75,000 ohms, 1 W., R10;
- Five Continental Carbon resistors, 1 meg., 1/2-W., R13, R14, R15, R16, R17;
- Two Continental Carbon resistors, 8,000 ohms, 1/2-W., R19, R20;
- One Electrad rheostat, 5,000 ohms, VR1;
- Two turns of wire around aerial lead, C1;
- Four Continental Carbon tubular condensers, 0.1-mf., 200 V., C2, C3, C4, C5;
- Four Continental Carbon tubular condensers, 0.25-mf., 200 V., C6, C7, C8, C9;
- Two Solar mica condensers, 100 mmf., C10, C16;
- Two Solar condensers, 0.1-mf., 400 V., C11, C14;
- Two Solar condensers, 0.05-mf., 400 V., C12, C13;
- One Solar condenser, 0.25-mf., 400 V., C15;

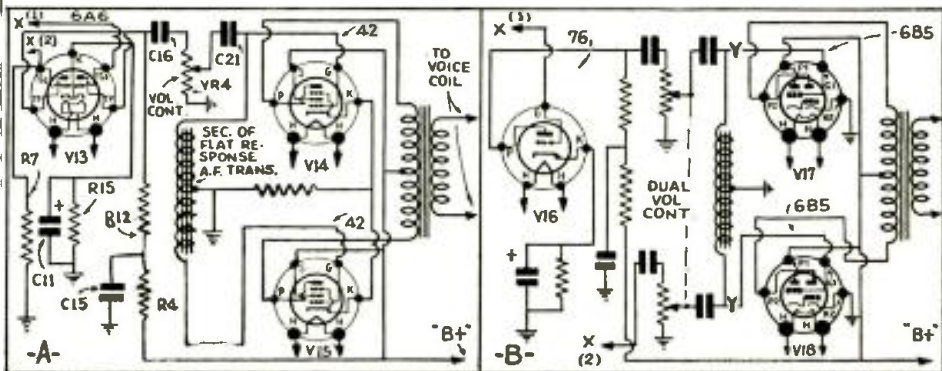

Fig. 3 A is an add-on unit for existing sets—B is a proposed circuit.

Please Say That You Saw It in RADIO-CRAFT

AWARDS IN THE \$1,800 OFFICIAL RADIO SERVICE HANDBOOK CONTEST

FOLLOWING are the names and addresses, and the letters, of the first two winners in the Official Radio Service Handbook Prize Contest sponsored jointly by Gernsback Publications, Inc., publishers of the Official Radio Service Handbook, and a number of the most important radio manufacturers.

First Prize. William Levi Zanes, P.O. Box 34, Deepwater, N. J. Award: United Sound Engineering Co. model CR5 frequency-modulated oscillator.

Second Prize. Edward M. Weiler, 410 Main St., Cedar Falls, Iowa. Award: Clough-Brengle Co. model CRA oscilloscope.

Additional data concerning the remaining winners and their awards will be announced in forthcoming issues of *Radio Craft*.

1st PRIZE LETTER

Gentlemen:

Too few Service Men understand or know the real essentials of successful servicing. In my opinion, an analysis of these essentials when summed up is tantamount to the old adage that "no workman is better than his tools." I've seen radio mechanics struggle earnestly and tediously with defective radio sets, simply because their test equipment wasn't quite up to the occasion of indicating the source of trouble. Most real Service Men will look with contempt on any of their brethren in this profession who employ low-resistance, insensitive voltmeters for making tests and measurements, or who attempt to align a multi-band superheterodyne receiver by ear and without the use of an all-wave signal generator.

It must be admitted that some Service Men operate under the aforementioned handicaps not because they are unaware of the deficiencies of their equipment, but for reasons of economy or insufficient finances. This, however, in my mind, is not sufficient excuse to warrant this practice. Where is economy effected when a job takes two to three times longer because of poor tools? And, how can a man expect his finances to improve when he wastes time on jobs which could be better utilized for drumming up new business? Then, of course, take into consideration the fact that a much better and more thorough repair job is possible with good equipment than with cheap or obsolete instruments. This factor in itself should be sufficient reason to warrant the replacement of old or inefficient test instruments by new units, since better repair jobs will always serve to bring new business through recommendations.

My particular pet peeve is the Service Man who is always building (and futilely using) short-cut trouble shooting gadgets that never amount to a row of pins. Perhaps I'm an "old conservative," but I've seen many Service Men wasting time (and money) on neon-tube capacity indicators that indicate roughly, very roughly, the relative capacity of a condenser. Or, a cathode-ray tube (or "eye") visual checker that supposedly will indicate the source of intermittent trouble, but usually is so critical that just touching the chassis will make the "eye" wink, probably in amusement. Me?—I use a brand new, complete analyzer that checks tubes, measures capacity accurately on a calibrated meter, measures all voltages (A.C. or D.C.) on a large, fan-type 2,000-ohms-per-volt (0.5-ma.) meter and does everything but shout out exactly what ails the set. And, aren't the customers impressed when I open the cover and proceed to make an analysis or some test on the receiver!

WILLIAM LEVI ZANES,
Deepwater, N. J.

2nd PRIZE LETTER

Gentlemen:

Many times in working with radio or public address equipment the Service Man with a limited stock of volume controls is often "up against it" when he needs a volume control of special value and with a special resistance taper. A little computation with the formula for resistances in parallel, gives us a series of curves. By choosing the correct values of both potentiometer and fixed resistance one may secure nearly any type of curve desired.

In the first series of curves to be considered, the fixed resistance was placed across the entire potentiometer as shown in Fig. 1A. In this as in the other series of curves a 10,000-ohm,

straight-line potentiometer was used in the calculations. The curves in Fig. 1A were figured for 1,000-, 10,000- and 100,000-ohm shunt resistances. In Fig. 1B the shunt instead of being across the whole potentiometer is across the load side only. Figure 1C shows the curves which result from placing a fixed resistor from slider to both ends. In Figs. 1B and 1C, X and X₁, are both 1,000-ohm resistors. If the Service Man is as handy with his mathematics as he should be, it will be no trick at all to amplify this idea so that he may obtain nearly any taper he desires for any circuit.

EDWARD M. WEILER,
410 Main St.,
Cedar Falls, Iowa.

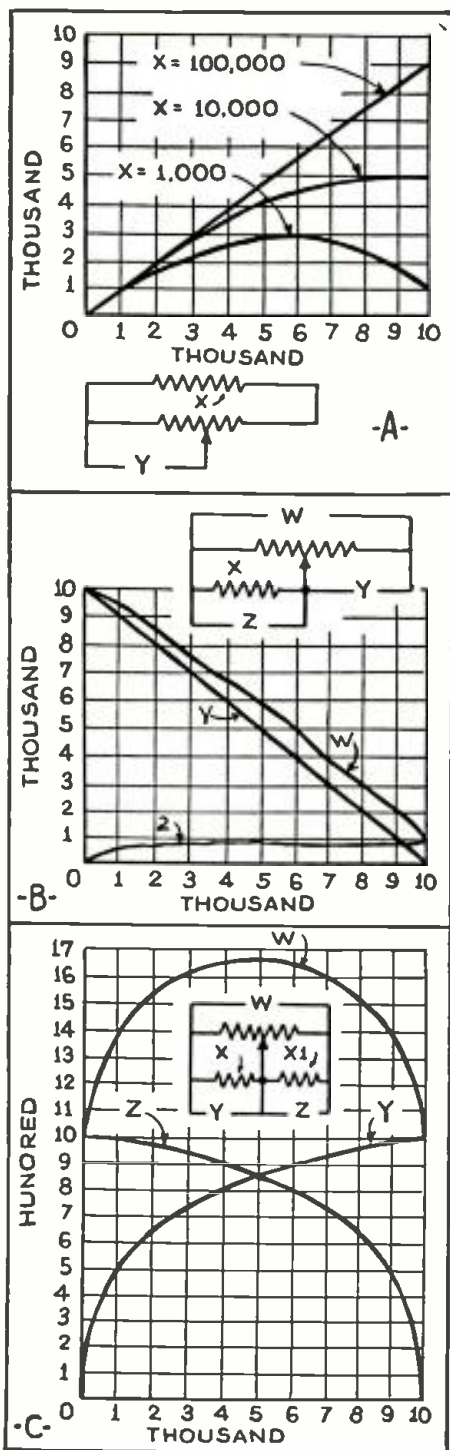

Fig. 1. Various curves described by Mr. Weiler. By choosing the correct value of resistance in shunt to the section of the potentiometer that is being varied, the curvature may be varied to meet emergency needs.

Train at Home Under FACTORY ENGINEERS for GOOD PAY Spare-Time and Full-Time Jobs in RADIO



LEARN TO EARN UP TO \$75 A WEEK

If you're dissatisfied with small pay—and an uncertain future, get my big FREE book, "RADIO'S FUTURE AND YOUR OPPORTUNITY." This book tells how you can learn at home under the supervision of factory engineers to make more money almost at once in Radio—how to make Radio your life's work, or how to earn \$5 to \$20 a week extra in your spare time.

MORE OPPORTUNITIES THAN EVER BEFORE

1935 was Radio's biggest year. Over 5 million new sets sold. Over 30 million dollars paid for service alone. Where only a few hundred men were employed a short time ago, thousands are employed today. And where a hundred jobs paid up to \$75 a week—there are thousands of such jobs today—many paying even more. New full time jobs and spare time jobs are being created all the time.

"SHOP TRAINING" FOR THE HOME

R-T-I Training is different. It comes to you right out of the factories where Radio sets and other vacuum-tube devices are made. It was planned and prepared and is supervised by radio engineers IN these factories—by men appointed for the purpose. R-T-I will train you as the Radio Industry wants you trained.



BIG MONEY IN AUTO AND POLICE RADIO WORK

W. H. Carr, 402 N. 16th St., Kansas City, Kans., R-T-I student, has charge of 35 radio equipped Police cars. He gets \$230.00 a month and free auto, gas, oil, etc. He says, "If I had not taken your course I would not be able to hold this job."



MAKES \$600 IN ONE MONTH

Herbert R. Thomson, Gorman, Texas, started making money with 12 lessons finished. He says, "Because of my R-T-I Training I made \$150 in September and over \$600 in October, 1935. It pays to be R-T-I Trained."

TELEVISION, PHOTO ELECTRIC CELLS, PUBLIC ADDRESS SYSTEMS INCLUDED

Radio service work is plentiful but it's only the starting point in R-T-I Training. From there you'll go through the whole field of Radio and Electronics. You will learn about every new development, including Television so you'll be ready when Television breaks.

4 WORKING OUTFITS FURNISHED

Start almost at once doing part time radio work. I furnish 4 outfits of apparatus that you build into test equipment with which you can do actual jobs and earn extra money. My training pays its own way, and you get your money back if not satisfied. Age or lack of experience is no handicap.

FREE BOOK

Find out why R-T-I Trained men get "Quick Results" and "Big Results." Send for "Radio's Future and Your Opportunity" today. It tells about Radio's amazing opportunities. It describes my approved training—what R-T-I students are doing and making. It gives the names of 50 firms who endorse and recommend R-T-I. It's FREE.

Ray D. Smith
President Radio and
Television Institute
Dept. 228
2150 Lawrence Ave.,
Chicago

MAIL COUPON FOR FREE BOOK

RAY D. SMITH, President
Radio and Television Institute (R-T-I)
2150 Lawrence Ave., Dept. 228
Chicago, Ill.

Without obligating me, send FREE Book about spare-time and full-time Radio opportunities and how I can train for them at home.

Name

Address

City State

Please Say That You Saw It in RADIO-CRAFT

For Football Stadium
or Dance Band—
the 60-C is Best



USE 60 WATTS NET
AUDIO OUTPUT \$76²⁶

● For large outdoor Public Address installations the U.S.E. Type 60-C Amplifier supplies the tremendous output required.

● Operated at lower volume as in dance band use, finest possible tone quality results, as the reserve power handles peaks that would otherwise distort. When the brass takes a break you'll get peaks of fifty watts even though average level may be only fifteen watts.

The 60-C includes All Modern Features, matched accessories reasonably priced.

Write for No. 106 complete catalog.

UNITED SOUND ENGINEERING CO.
2239 University Avenue, St. Paul, Minn.

BLOCK power line NOISE



Enjoy
good
quiet radio reception

Most crackling noises in your radio reach the set through your power supply lines. The power line interference is radiated from your house wiring to your radio and aerial.

This man-made static can be blocked where the main lines enter your dwelling! Filtercon F1005DH is designed to block with inductance and filter to ground, through capacitance, power line interference. Enjoy radio free from the interference of your neighbor's electrical equipment.

Ask your radio supplier for Filtercon F1005DH. List price, \$5.00.

Send for Resistor-Filtercon
Bulletin 101A



13914 Lorain Ave., Cleveland, O., Toronto, Canada

HOW TO MAKE AN OSCILLOSCOPE

(Continued from page 279)

is the type with which we have the most trouble. Amplitude distortion arises whenever a vacuum tube is operated beyond its linear characteristics, as for instance, when overloaded. Harmonic frequencies appear in the output which were not present in the input. In addition to the tubes, a further possible cause of amplitude distortion may arise from impedance mismatching or saturation of transformer cores and windings. A double check of this type of distortion is easily made with the oscilloscope and A.F. oscillator.

Phase distortion in audio amplifiers need not concern Service Men as a problem. A definition, however, might be of interest. When the phase relation existing between various frequencies at the input, changes for any reason by the time the frequencies reach the output, a change in the original waveform will result. The ordinary tone control as an example, is a producer of phase distortion when it mutes the high notes. A test for phase distortion requires an A.F. oscillator which contains in its output, harmonics which are sufficiently strong to appear in the waveform. See Fig. 10C. This complex signal fed to the amplifier should be viewed on the oscilloscope both at the input and output. Any change in the waveform will show that there is phase distortion in some degree. Both frequency and amplitude distortion must be at minimum or else they may be causing changes in waveform at the same time.

Hum ripple voltage may be studied and traced to its source by using the oscilloscope as shown in Fig. 10D.

Checking selectivity, peak frequency and gain of I.F. transformers should be of interest to set builders. A setup for this purpose which was used by the author is shown in Fig. 10E.

Referring back to audio amplifier overload, a setup shown in Fig. 10F is used and the following points must be observed: (1) both amplifiers in the oscilloscope should be ON or both should be OFF; (2) one amplifier alone should not be used; (3) no sweep voltage or synchronizing voltage is required for this test; (4) the gain of both amplifiers should be equal (if used) or else the diagonal line which appears on the screen will tilt.

In conclusion, the author suggests that the Service Men who have built the oscilloscope keep a record of the connections and a tracing of unusual images in a notebook set aside for that purpose, so that in time, they will have an operating manual of great utility, at their disposal.

(Let us know how you "make out" with this unit.—Editor)

USING HEADPHONES IN SERVICE WORK

(Continued from page 280)

of trouble is in the power supply filter. By placing a high-impedance headset directly across the voltage-dropping or bleeder resistor of the power section, the presence of any undesirable alternating component can be immediately detected. (It should be noted in this connection that with a high-impedance, magnetic-type receiver this is not particularly injurious to the higher-grade headsets if done for a short time, but due to the sharp crash of sound on making the circuit, it is advisable to place in series with the receiver a resistor having a value of about 0.1-meg.)

Locating distortion. In the isolation of the source of distortion, the trouble can be located frequently by placing a headset in the circuit at various points. Up to the present time, there has been no method devised that is more conclusive for checking distortion than the "listening test." In practically all radio sets, loudspeakers, and for that matter all communication devices, the final analysis is made by aural means.

In general, it can be said that headphones provide at low cost a very effective tool in the analysis of trouble in servicing radio sets. Methods which are easily performed coupled with a definite testing routine will provide the wide-awake Service Man with a larger percentage of the service work because of his more apparent mastery of the subject at hand.

This article has been prepared from data supplied by courtesy of Trimm Radio Mfg. Co.

Please Say That You Saw It in RADIO-CRAFT

THE AUTOMATIC BALLAST CONTROL RADIO TUBE TESTER

Model ABC*

A radically new development in tube tester design. Functions similar to AVC control on radio set. WEAK tubes driven well back in BALL. 1,000 tubes of same type but different make, that test widely apart on usual tester will read at nearly same point on ABC due to ballast action. Portable. Large adjustment. Neon short and leakage test of all elements. Bakelite panel. Oak case. Price net to servicemen \$34.75. Time payments. Send for circular.

*Patents applied for.

L & L ELECTRIC CO.
346 Madison Ave. Memphis, Tenn.

RADIO COURSES

RADIO OPERATING: Prepare for Gov't License Exam. ● RADIO SERVICING: Including Short Wave ● AMATEUR CODE ● New Course in ELECTRONICS: Day and Evening Classes—Booklet Upon Request
New York YMCA Schools
4 W. 64th Street, New York City

VAN SHUNTS and DIALS

for your small meters!
301-88-321 and 54

Many dealers are now able to supply you, or write us for name of nearest dealer.

New Address of **VAN Laboratory**
D. L. VAN LEUVEN

558-AA West 132nd St. New York, N. Y.



"HAM" SPECIAL Standard Teleplex

A highly efficient code teacher using heavy specially prepared waxed paper tape, having two rows of perforations. Write for Free folder A10. We are the originators of this type instrument

Instrument with tapes prepared by expert and complete course; all for \$11.95. Without oscillator, 72-76 Cortlandt St., N. Y. C.

ATTENTION SET BUILDERS

4 TUBE T. R. F. KIT
1 ANT. 1 R. F. COIL
1-2 GANG CONDENSER
SCHEMATIC DRAWING **89^c**

Write for FREE RADIO PARTS Circular
ARROW SALES CORP., 631 Washington Blvd., Chicago, Ill.

NEW GUIDE NOW READY!

Most complete volume control facts ever assembled in one book. Free with one complete Electrad carton.

Write Dept. RC11

175 Varick St., New York, N.Y.

ELECTRAD
INC.

BE OUR AGENT

★ Sell our complete line of 16 MM and 35 MM motion picture equipment for theatres, institutions, clubs and home use. We have everything. Tremendous field; liberal profits. Write TODAY.
S.O.S. CORP., 1600-RA B'D'W'Y, N.Y.C.
CABLE—SOSOUND, N.Y.

OXFORD NEW SPEAKERS

... with "Changeable Fields" and Universal Trans-former, bring you new convenience, performance and economy in Speaker Replacements. Ask Your Jobber or Write today for Bulletin 361C.
OXFORD-TARTAK RADIO CORP.
915 W. VAN BUREN ST. CHICAGO, U.S.A.

The OFFICIAL RADIO SERVICE HANDBOOK is NOW READY. Please turn to page 261 of this issue and get full details of radio's greatest book on servicing.

BUILD THIS BEGINNER'S 2-TUBE A.C.-D.C. RECEIVER

(Continued from page 284)

tubes. One of these functions as a half-wave rectifier tube, the grid and plate terminals being connected together for this purpose. This tube changes the house current into a form which is suitable for use in the receiver. The other tube operates as a highly efficient and sensitive regenerative detector and under fair conditions is capable of picking up even the faintest of signals. The aerial may be any length of wire from 30 to 100 ft. and erected as free from obstructions as possible. No ground connections are required as the house current system is itself grounded.

LIST OF PARTS

- One Hammarlund 85 mmf. antenna series condenser, C1;
- One Hammarlund 140 mmf. variable cond., C2;
- One Solar 250 mmf. grid condenser, C3;
- One Solar 250 mmf. bypass condenser, C4;
- One Solar filter condenser, dual section type, C5;
- One Continental Carbon 2 meg. resistor, R1;
- One Cont. Carbon 50,000 ohm resistor, R2;
- *One 0.1-meg. regen. control, R3;
- One Eilen special line cord, R4;
- One Eilen black bakelite dial;
- One Eilen set of 4-brong S.W. coils;
- One Eilen special cabinet, drilled and finished in black crackle;
- Two Arcturus type 37 or 76 tubes.

*Names and addresses of manufacturers will be furnished upon request.

This article has been prepared from data supplied by courtesy of Eilen Radio Labs.

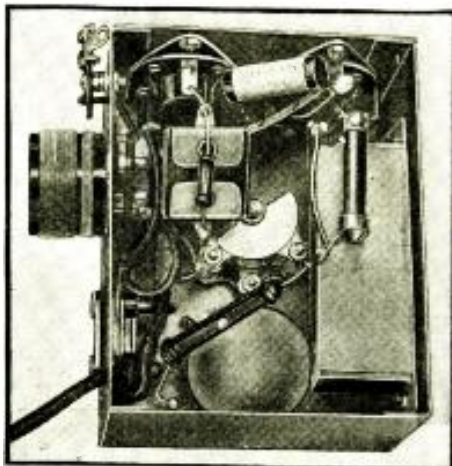

The interior of the set showing layout.

PROS AND CONS OF MICROPHONE TYPES

(Continued from page 287)

is employed. This has the added advantage of producing a far better frequency response than the diaphragm type.

Advantages: The crystal microphone is rugged, suitable for both indoor and outdoor work.

Limitations: Low output and high impedance.

Condenser Microphone. The condenser microphone operates upon the principle of changing capacity between 2 electrodes. A stretched metallic diaphragm is insulated and separated by a very small distance from a flat electrode. In this case the sound pressure waves, striking the diaphragm, cause it to move, thereby changing the capacity.

Advantages: Frequency response is considerably improved over the carbon microphone and also has a low inherent noise level.

Limitations: Low output which requires polarized potential for its operation and it is difficult to keep in operating condition due to the extremely small clearance between the diaphragm and the back plate. It is not used very extensively.

Dynamic Microphone. The dynamic type of microphone is a completely self-contained unit that does not require field excitation.

Advantages: The dynamic microphone has a low impedance and its noise level is low.

Limitations: It is heavy and must be handled with extreme care.

Our Information Bureau will gladly supply manufacturers' names and addresses of any items mentioned in Radio-Craft. Please enclose stamped return envelope.



SCOTT PERFORMANCE Begins WHERE THE OTHERS STOP

Here's a target for distance sharpshooters all over the world to level guns at! Here is proof that the SCOTT ALLWAVE is the finest receiver in the world!

From F. L. Stitzinger in Pennsylvania comes this verified list of 34 foreign countries, 98 foreign stations, 1651 foreign programs — not merely logged, but verified! All within a short six months period! No other receiver in the world has equalled this verified world record performance during any six consecutive months tuning! — Argentine, Australia, Belgian Congo, Bermuda, Bolivia, Brazil, Belgium, Canada, Columbia, Costa Rica, Cuba, Denmark, Ecuador, England, Federated Malay States, France, Germany, Hawaii, Holland, Indo-China, Italy, Japan, Java, Kenya Colony, Mexico, Morocco, Peru, Portugal, Republic Dominica, Russia, Spain, Uruguay, Venezuela! Every station, every program, verified!



E. H. SCOTT, designer and custom-builder of world's finest radio receivers since 1924

MR. SCOTT'S PERSONAL MESSAGE TO YOU

Says Mr. Scott: "Mr. Stitzinger's list is only one of thousands which SCOTT owners constantly send in to our laboratories — SCOTT owners receive and have verified 3 times as many foreign stations as are received on sets of other radio manufacturers . . . SCOTT ALLWAVE receivers are giving distinguished service in more than 146 countries throughout the world. . . . We have over 600 expert 'Installation and Service representatives' over entire United States alone — to give you instant service should you ever need it. This, even though every SCOTT receiver carries five year guarantee of perfect service."

FACTS ARE YOUR GUARANTEE

Here is reception not even approached by any other receiver anywhere on earth — regardless

of price! This is not "sales talk." These are vital facts — of deep interest to every DX enthusiast.

To enjoy the really great world music, to hear the tremendous events which are moulding history — still to be in tomorrow's headlines — you must have high Class "A" speaker power.

SCOTT 23 TUBE ALLWAVE has 35 Watts Strictly Class "A" Power, 50 watts Class "A-B" power — 6 times undistorted output of average receiver — for vaster distances.

Bullet-Direct Variable Selectivity 2 to 16 KC — 3 times better than selectivity of average receiver — to pierce through powerful local stations and bring in weak distant stations thousands of miles distant.

6 Microvolt Sensitivity — Twice that of any other radio receiver.

25 to 16,000 Cycle Hi-Fidelity — provably twice the tonal range of any other high fidelity receiver — a fact which we can demonstrate in any comparative test.

Dial Calibration — accurate on all tuning bands for the first time in radio history.

Foreign Station Locator — tunes in the short wave stations instantly.

Builder of WORLD'S FINEST CUSTOM-BUILT RADIO RECEIVERS Since 1924

More Important PERFORMANCE Features Than Any Other Receiver — including True Bass Control — True Separate Treble Control — 23 Tubes, New Highest Efficiency Type — Oversize Construction throughout — includes many advanced laboratory developments which cannot be incorporated in production type radio receivers.

Compare It in Your Home

These celebrities demand the world's finest quality — all are SCOTT owners — Toscanini — Guy Lombardo — Eddie Cantor — Walter Winchell — Ted Husing — Rudy Vallee — Al Jolson — and hundreds more. The SCOTT is the choice of Presidents and Princes all over the world.

Unqualifiedly guaranteed to bring you more foreign stations with stronger volume, with more crystal clear tone, with less noise than any other receiver in the world — in your own home! 30 days' trial. You can own the SCOTT for no more than you would pay for an ordinary receiver.

The Secret of Superiority

How is such an unequalled guarantee possible? The SCOTT is strictly custom-built — to highest precision standards known. Sent to you direct from laboratories — fully adjusted and proved, with nationwide installation service.

Read coupon below — NOW — and decide right now — without delay — to send for the most thrilling story of world-covering performance in the history of radio!

Visit our new permanent salon at 630 Fifth Ave., Rockefeller Center, New York City; or 115 N. Robertson Blvd., Los Angeles, Cal.

E. H. SCOTT RADIO LABORATORIES, Inc.
4404 Ravenswood Ave., Dept. 2476, Chicago, Ill.

Send "94 PROOFS" of the SCOTT'S superior tone and DX performance, and particulars of 30-day home trial anywhere in U. S. A.

Name.....
Street.....
City..... State.....

THERE'S A GOOD JOB FOR YOU IN RADIO

We Will Train You Quickly to Qualify

The servicing of modern radio receivers requires experts — men trained for this work are needed everywhere.

RADIO OFFERS BIG OPPORTUNITIES

Your possibilities of making money are limited only by your ability and skill. There is no room for the soldering iron "guesser." But you must be trained — the sooner you begin the quicker you'll cash in.

LEARN AT HOME

We will train you at home to service and repair radio receivers of all types. Invest for future success in R.T.A. training.

NO EXPERIENCE NEEDED

You need no previous experience in radio. We show you how to make money almost from the start. Hundreds of men are enjoying the rewards of R.T.A. training.



FREE of extra cost

This time saving trouble-finder and circuit analyzer included.

Full details of this great opportunity are explained in a helpful book that is **FREE**. Send for it today. It will be mailed at once.

RADIO TRAINING ASS'N OF AMERICA
Dept. RC-611, 4525 RAVENSWOOD AVE., CHICAGO

FOUR NEW THORDARSON CATALOGS

Tru-Fidelity Catalog No. 500

A complete listing of the entire Tru-Fidelity line of transformers. Profusely illustrated with working curves of each transformer. A complete treatise on the finest radio transformer built for commercial production.

Complete Transformer Catalog Catalog No. 400. No radio engineer, serviceman enthusiast or ham should be without this big 16 page catalog. Lists every radio transformer (except Tru-Fidelity) made by THORDARSON. Send for your copy today or see your radio parts distributor.

Radio Servicing Guide It's here! THORDARSON'S new 32 page Radio Servicing Guide. Chock full of worthwhile suggestions. Profusely illustrated. Ideas on how to correct many problems in the service business. Send direct or buy it from your parts jobber.

Transmitter Guide Amateurs Attention! Europe and South America at your call. Thrill to trans-oceanic reception. Build finest amateur transmitters. Many other subjects treated in this book. Send direct or buy it from your radio dealer.

THORDARSON ELECTRIC MFG. CO.
500 W. HURON ST., CHICAGO, ILL.
Demand "Power by Thordarson"



Built to Stand the Gaff!

In that transmitter assembly, AEROVOX oil-filled condensers insure you against breakdowns. ● Popular round-can units are now mass produced and sold at very low prices. ● Genuine oil-impregnated, oil-filled units. Seepage-proof container. High-voltage pillar terminals. No plate flutter. Mounting rings. ● A quality product for lean pocketbooks!

New CATALOG covers complete condenser and resistor line. Write for it, as well as sample copy of monthly Research Worker.

AEROVOX CORPORATION
77 Washington St. : : Brooklyn, N. Y.

AN EASILY-BUILT 4-TUBE PORTABLE SET

(Continued from page 281)

batteries. The full carrying weight is approximately 12 lbs.

Experiment proved that the magnetic speaker specified in the List of Parts delivered the best tone and highest output. While the life of the midget batteries is not equal to batteries of larger size, the exceptionally low drain of 0.3-A. "A" current and 15 ma. "B" current is figured to give very satisfactory use. There is practically no current drain from the "C" batteries.

Parts are relatively inexpensive and the results fully warrant the construction of this portable set; which is light in weight, compact in size, costs little to make and operate, and has fine range and volume.

LIST OF PARTS

- One Thor special chassis;
 - One Thor 2-gang variable condenser, 350 mmf;
 - One Wholesale Radio Service Co. antenna coil, litz wound;
 - One Wholesale Radio Service Co. oscillator coil, 465 kc., litz wound;
 - Three Thor tube shields;
 - *Three 4-prong wafer sockets;
 - *One 5-prong wafer socket;
 - *Two iron-core I.F. transformers;
 - One Centralab potentiometer, 50,000 ohms, and Sw.;
 - One Thor dial to match condenser;
 - One Thor fuse and mounting, 1/2-A.;
 - One 6-wire battery cable;
 - *One "chromatic-magnet" speaker;
 - One leatherette carrying case;
 - One Thor panel to fit case;
 - One Hammarlund paddler, 500 mmf.;
 - *One "A" battery 3 V., 200 series;
 - *Three "B" batteries, 45 V., 200 series;
 - *One "C" battery, 7 1/2 V., 200 series;
 - One Raytheon 1A6 tube;
 - One Raytheon 1A4 tube;
 - One Raytheon 1B4 tube;
 - One Raytheon 950 tube;
 - Two I.R.C. resistors, 50,000 ohms, 1/2-W.;
 - Two I.R.C. resistors, 0.1-meg., 1/2-W.;
 - One I.R.C. resistor, 1/2-meg., 1/4-W.;
 - Three I.R.C. resistors, 0.75-meg., 1/4-W.;
 - One I.R.C. wire-wound resistor, 2 ohms, 2 W.;
 - Six Cornell-Dubilier condensers, .01-mf., 200 V.;
 - One Cornell-Dubilier mica condenser, 100 mmf.;
 - One Cornell-Dubilier mica condenser, 500 mmf.;
 - One Cornell-Dubilier condenser, 0.006-mf., 400 V.;
 - Two Cornell-Dubilier condensers, 0.01-mf., 400 V.;
- *Names and addresses of manufacturers will be sent upon receipt of a stamped and self-addressed envelope.

This article has been prepared from data supplied by courtesy of Thor Radio Co.

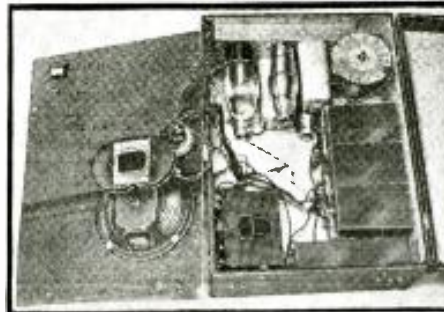

Note the positions of dial and speaker.

ORSMMA MEMBERS' FORUM

(Continued from page 280)

This is our idea of a "swell" constructive letter. Let's see if any other Radio-Craft readers can reach Disney's "par." Thanks, "E. H." for your kind remarks about "R.-C."

THE ELECTRAD CONTACT (Magazine)

"In constant touch with the radio service world" is the slogan of this new house organ by Electrad, Inc. Issue No. 1 (May, 1936) of Vol. I contains an informative answer to the question, "Why is a Baffle necessary in a loudspeaker?"; the remaining 7 pages contain miscellaneous material of interest to the Service Man. In size, Contact measures 8 x 11 ins.; Mr. L. A. deRosa is the editor.

Please Say That You Saw It in RADIO-CRAFT

RADIO ENGINEERING,

broadcasting, aviation and police radio, servicing, marine radio, telegraphy and telephony, Morse telegraphy and railway accounting taught thoroughly. Entering course of nine months' duration equivalent to three years of college radio work. All expenses low. Catalog free. School established 1874.

Dodge's Institute, Hudson St., Valparaiso, Ind.

RADIOS AT A GREAT SAVINGS BUY DIRECT

Many models to select from. Factory prices. A.C.-D.C. All Wave, farm, car, and new metal tube models. Public Address and Communication Systems. Send for new 1936 bargain catalog free.

AUTOCRAT RADIO COMPANY
3855 North Hamilton Avenue Dept. 250 Chicago, Illinois

There's More than Efficiency in TRIMM FEATHERWEIGHTS

We at Trimm take a personal pride in the products we manufacture—this assures you of the finest headset that can be made. Available from all of the discriminating jobbers.

TRIMM RADIO MANUFACTURING CO.
1770 W. Bertau Ave., Chicago, Ill.

BUILD IT YOURSELF

You can build this Trailer with ordinary tools easily from our step-by-step constructional sheets and large sized blueprints. Finest designed Trailer in existence, slope 4. Toilet, Shower, Electric Light, etc. Save 75% of the cost by building it yourself. Send 25c for plans sheet, illustrations and details.

THE PLAN SHOP, 910 Palmolive Bldg. Chicago, Ill.

To Readers of RADIO-CRAFT

FREE POSTCARDS MAY BE HAD UPON WRITING TO THE PUBLISHERS

These post cards make it easy to answer advertisements which appear in RADIO-CRAFT, without cutting valuable data which you may wish to save. Many times manufacturers request you to "clip the coupon" when answering their ads. Often this means destroying part of an article on the reverse page you may need later for reference. Save your RADIO-CRAFT issues complete. If you should ever want to sell bound volumes, or certain copies of RADIO-CRAFT, the resale value of uncut issues is very much higher than that of mutilated ones. So send for a supply of these free post cards and use them in answering all RADIO-CRAFT advertisers.

TYPEWRITER BARGAIN



BRAND NEW MODEL No. 5 REMINGTON PORTABLE

● A brand new Remington for only 10c a day. An easy, practical Home Typing Course FREE. With it anyone quickly becomes expert on this machine... the most rugged, dependable portable made. Not used or rebuilt. Standard 4-row keyboard. Standard width carriage. Margin release on keyboard. Back spacer. Automatic ribbon reverse. Every essential feature of big office typewriters. Carrying Case FREE. Try it for 10 days without risking a cent. If you don't agree it is the finest portable at any price, return it at our expense. Don't delay. Without obligation, write now.

REMINGTON RAND INC.
315 Fourth Ave. Dept. 189-11 New York, N. Y.

THE LATEST RADIO EQUIPMENT

(Continued from page 283)

be of any length up to 2,000 ft. Equal results are obtained by use of this transformer and a low-impedance velocity microphone as with an ordinary high-impedance mike, and as many as 4 velocity mikes may be fed into 1 transformer. Hum pick-up is entirely eliminated due to the design; and the case is of an alloy which will stand much abuse. Either a 50- or 200-ohm mike may be fed into the standard input of 200 ohms at the transformer.

26 W. AMPLIFIER (1203) (Amplitone Products Co.)

A DUAL power unit, operating from either 110 V. A.C. or 6 V. D.C. is a feature of this P.A. amplifier, which supplies an overall gain of

112 db. and a peak output of 35 W. The normal output is 26 W. with a frequency response of 40 to 10,000 cycles (within 2 db.). A 2 position mixer for crystal and velocity mikes is employed; output impedances are 2, 4, 8, 15 and 500 ohms. Tubes are 1-6J7; 3-6N7; 1-6F6; and 1-83.

POCKET VOLT-OHMMETER (1204) (Powertone Electric Corp.)

A SENSITIVE and compact instrument for the Service Man. Direct current voltage readings of 0-5, 50, 500, and 1,000; resistance readings of 1/2-500 and 200 to 500,000 ohms; and current reading of 0-1 ma. are provided.

The meter has a sensitivity of 1,000 ohms per volt. The battery is self-contained and a compensator corrects for drain on battery. Measures 5 x 3 1/4 x 2 1/2 ins.



Left, a dual power P.A. amplifier, operating from either 110 V. A.C. or 6 V. D.C. Uses an 83 rectifier for A.C. and a generator motor for storage battery operation. (1203) Right, a cable type transformer for adapting low impedance mikes to high impedance circuits.

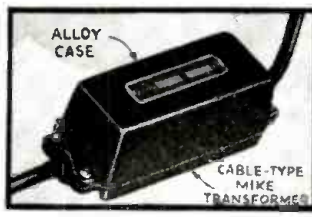

ALLOY CASE
CABLE-TYPE MIKE TRANSFORMER

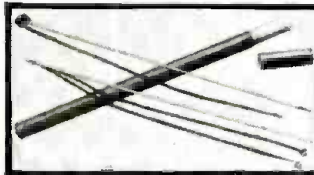

A demonstration all-wave antenna which is hung from a window for "selling" all-wave sets. (1197)



6,000 V. condenser. (1200)

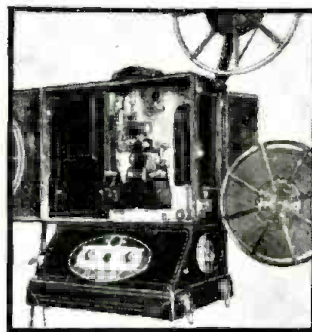

De luxe projector. (1198)

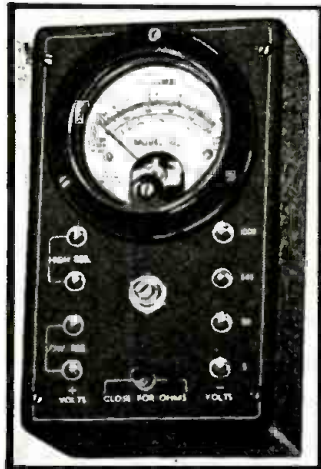

Pocket volt-ohmmeter. (1204)

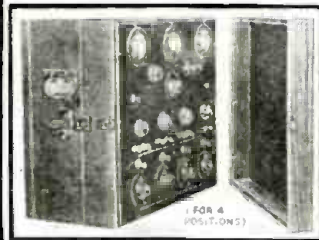

Portable amplifier. (1201)

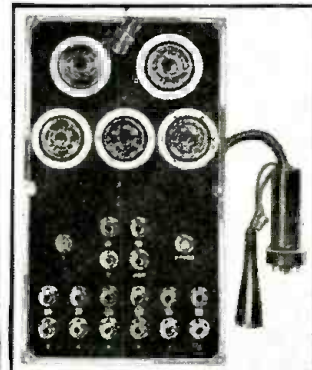

Analyzer panel. (1199)

BOOK REVIEWS

OFFICIAL RADIO SERVICE HANDBOOK, by J. T. Bernsley. Published by Gernsback Publications, Inc., 1936. Size 5 1/2 x 8 1/4 ins., 1008 pages. Price \$4.00.

This book is especially written for the use of Radio Service Men, as an up-to-date reference and text. So many technical changes have been made recently in the radio receivers, amplifiers and other units encountered by the Service Man in his business of repairing radio equipment that new measuring and indicating instruments and methods are entirely different than they were even a few years ago. Take for example the high-fidelity receivers which are making their appearance in greater and greater numbers. These sets can not be repaired and aligned by the old method of "listening"—accurate tools and test units have to be used to put them to rights, when they go "haywire." Hence, the oscilloscope, wobbler, V.T. voltmeter, signal generator, etc. have made their appearance.

It is the purpose of this book to instruct the

technician how to properly and intelligently use these and other servicing "tools."

Some of the important subjects covered in this valuable book are: Circuit fundamentals; Intricate Tuning Circuits and aligning data; Volume control, tone control A.V.C. and resonance-indicator circuits; Receiver A.F. amplifier systems; Receiver power supplies; Loudspeakers, pickups and electric phonograph equipment; Fundamentals of meter and test instruments; Commercial types of test equipment; The cathode-ray oscilloscope and supplementary equipment; How to build essential servicing and test instruments; Hints on localizing trouble; Short cuts with test equipment; Hints on receiver repairs; All-wave high-fidelity receiver data; auto-radio installation and service; Specialized installation and servicing; Noise interference elimination; Modernizing and improving receivers; Receiver conversion work; Improving knowledge and technique; Uplifting the Profession; and Operating notes.

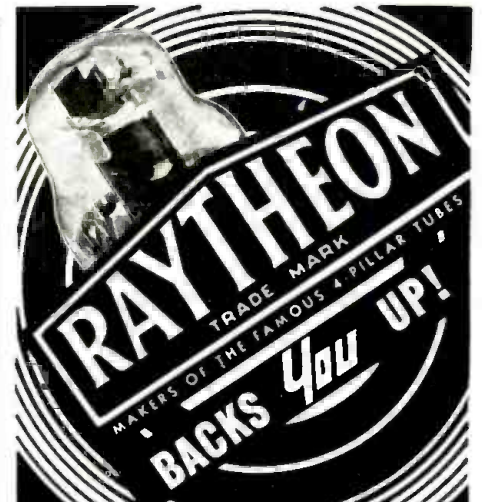

TO AID RAYTHEON DEALERS IN FULLY CAPITALIZING ON THE TREMENDOUS PUBLIC ACCEPTANCE OF RAYTHEON'S QUALITY AND NAME, OUTSTANDING SELLING HELPS ARE SUPPLIED RAYTHEON DEALERS, INCLUDING SIGNS, POSTERS, BANNERS, COUNTER CARDS, WINDOW DISPLAYS, NEWSPAPER MATS, REPLACEMENT CHARTS, TECHNICAL DATA SHEETS, POCKET TROUBLE SHOOTERS, ETC.

WRITE RAYTHEON TODAY FOR YOUR SUPPLY OF THESE AIDS TO GREATER TUBE PROFITS.

THE MOST COMPLETE LINE—ALL TYPES OF GLASS, OCTAL BASE, METAL AND AMATEUR TRANSMITTER TUBES.



RAYTHEON TUBES ARE PREFERRED AND RECOMMENDED BECAUSE THEY MEET THE EXACTING REQUIREMENTS OF LEADING SET ENGINEERS.

RAYTHEON PRODUCTION CORPORATION

420 Lexington Ave. 55 Chapel Street
New York, N. Y. Newton, Mass.
445 Lake Shore Dr. 555 Howard St.
Chicago, Ill. San Francisco, Cal.
415 Peachtree Street, N. E.
Atlanta, Ga.

Please Say That You Saw It in RADIO-CRAFT

64 WATTS (Undistorted) POWER AMPLIFIER

Employs RCA's Miracle Tube Development 4-6L6 Beam Power Output Tubes!

● PROVIDED WITH DUAL OUTPUT CHANNELS (32 WATTS EACH)
Multiple Input Channels 1 or 2 Velocity Diode Mikes (128 db.), 1 or 2 Crystal Mikes (107 db.), 1 Photo pickup (65 db.). ● Electronically Mixing Fading System ● 2% Distortion Guaranteed ● True High-Fidelity Performance finally achieved! ● Field Supply: 100 Volts D.C. 130 mts. ● Universal Output Impedances in both channels: 500, 10, 8, 4, 2, 1 ohms ● Polarized, Shielded and Armored Input & output Plugs and Receptacles. ● 11 Metal Tubes employed. ● Individual Filament & Plate Voltage Switches with accompanying Vari-colored crystal Pilot light indicators. ● Unreserved Guarantee: Two years.



\$49.50

RCA Tubes \$11.25
Models also obtainable for 6-Volt Battery Operation!

SEND FOR AMPLIFIER BULLETINS
Permit our staff of engineers to plan and select your next amplifier system. They will show you how to save money and yet obtain finest quality equipment. Write us your requirements!

INDUSTRIAL AMPLIFIER SYSTEMS COMPANY
16 HUDSON STREET :: :: :: NEW YORK, N. Y.

INTRODUCING—A NEW TYPE "AUDIO" A.V.C. BEAM AMPLIFIER

(Continued from page 28s)

amplifiers is difficult to describe in words. Perhaps the best way to express the general idea is to paraphrase the comment of a notable singer who had not yet become familiar with microphone technique, to wit:

"The mental ease of the performer is the most desirable feature that can be put into a P.A. system. The modern sound system is really a kind of servant and perhaps there is no better way to sum up what I expect from a sound system than to consider what I expect from a servant. I expect a servant to be dependable, efficient; ready to serve me constantly, willingly, pleasantly—and without 'back talk'."

IMPORTANCE OF THE "—OLOGIES"

One need not delve into text books on these ponderous subjects to study their inter-relation with P.A. systems. A casual observation and study of many P.A. installations will disclose the following undesirable physiological, psychological and neurological reactions which take place in 99 out of 100 unrehearsed P.A. applications.

1. The orator has no way of telling how his voice is coming over the system or whether he is standing too close or too far from the microphone.
2. When the volume of reproduced sound is too loud it becomes annoying and distracts the audience.
3. When the volume of reproduced sound is too low, those of the audience who cannot hear, become talkative.
4. A talkative audience upsets most orators.
5. Enthusiastic orators turn from side to side.

TWO-TUBE SHORT WAVE RADIO « ONLY \$3.00

less tubes, phones, unwired



A REAL powerful 2 tube short wave set that readily brings in amateurs, police calls, broadcast stations, experimental and foreign stations under fair conditions. **THE WORLD AT YOUR DOOR!**

A **DEPENDABLE RECEIVER** which is guaranteed to give **RESULTS**. Operates entirely from the AC or DC house current. Simple to build and easy to operate. Beautiful, black shrivel finished cabinet and instructions furnished. Wave length range 10 to 600 meters.

TWO TUBE BATTERY SET, less tubes, phones batteries, unaltered. \$2.00
Kits wired, extra \$0.75. Tubes, each. \$0.50
1"antenna (double headphones) \$1.35
24 hour service. 20% deposit on C.O.D. orders

FREE

Large, illustrated 20 page catalogue of short wave receiver kits, transmitters, and accessories. Send stamp to cover postage and handling charges.

EILEN RADIO LABORATORIES, Dept. RC 11, 136 Liberty Street, New York, N.Y.

Sensational RADIO VALUES

4-Tube AC-DC Set
Buy at factory prices—Save money! Lowest priced good radio on the market. Uses 4 latest type tubes, sensitive magnetic speaker, aerobline dial, built-in antenna and attractive cabinet with beveled corners, Astounding volume and tone quality. Uses 1-6G6, 1-4D6, 1-43 and a 2Z5. Works anywhere on any 110-volt circuit. Covers the standard broadcast band. A real portable personal set. Can be carried anywhere.

\$6.45

5-Tube A.C.-D.C. Dynamic Speaker Short-Waves—Aeroplane Dial

5 latest tubes, 6" dynamic speaker, illuminated aeroplane watch dial, built-in antenna, beautiful two-tone cabinet. Two models, viz: Broadcast Model (\$8.95), and Short-Wave and Broadcast Model (\$10. extra). Works on any 110-volt line—AC or DC. Order directly from this "Ad."
Send certified check or money order. 20% deposit required for C.O.D. orders. **WRITE TODAY FOR FREE ILLUSTRATED CIRCULAR**—large selection of latest radio and television offers.

PARAMOUNT TRADING CO., 80 EIGHTH AVE., NEW YORK CITY.

MILLION TUBE TESTER



- FEATURES**
1. Emission
 2. Metal Tubes
 3. Shorts HOT
 4. Leakage HOT
 5. Resistance
 6. Electrolytics
 7. By-Pass Condensers
 8. Neon Alignment

MODEL CN \$9.95 NET

Here's what the Service Men say about the New Million Tube Tester: "Most valuable purchase of test equipment we made during the last year." "It shows up weak tubes better than any expensive—tester."
If your jobber cannot supply you—order direct—20% deposit required on C. O. D. orders. Tear out this ad and send it to us NOW for information on complete line.

MILLION RADIO AND TELEVISION LABORATORIES
361 W. SUPERIOR ST., CHICAGO, ILL.

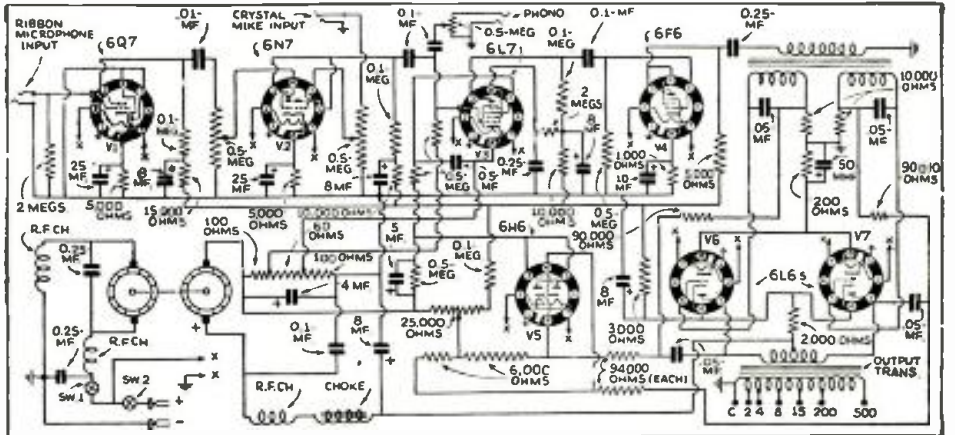

Fig. 1. The circuit of the A.V.C. amplifier designed for mobile work.

A COMPLETE OSCILLOSCOPE "SERVICER"

(Continued from page 248)

An analysis of the above characteristics will show the radio man that this instrument combines all the flexibility of separate units.

Our Information Bureau will gladly supply manufacturers' names and addresses of any items mentioned in Radio-Craft.

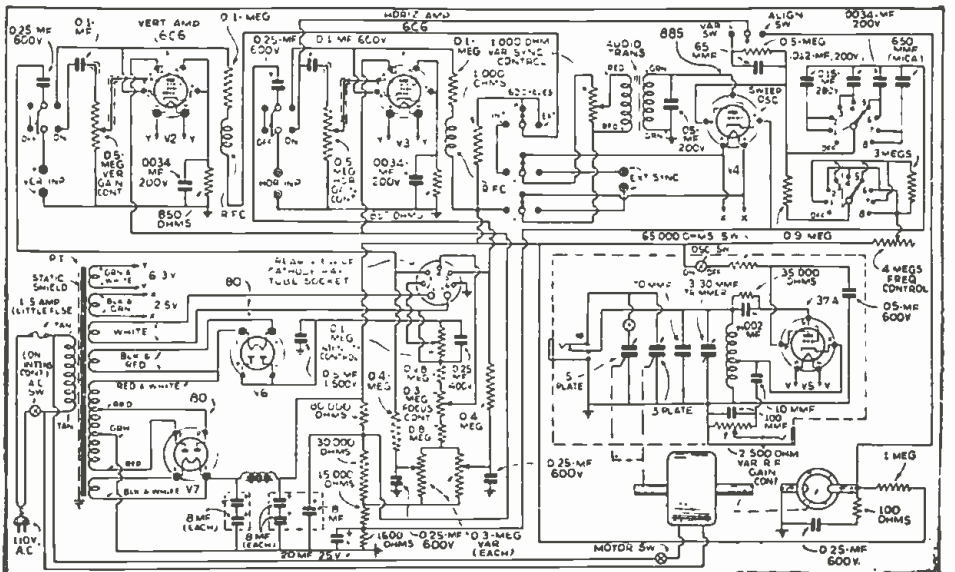

The schematic circuit of the oscilloscope unit, including all values.

Please Say That You Saw It in RADIO-CRAFT

thus causing rapid and wide fluctuations in volume so that the conditions listed under Nos. 2 and 3 set in before the operator can manually monitor the program.

6. Virile orators (particularly, the "electioneering" type!) stress important points by raising their voices to "yelling" levels. This inevitably overloads the amplifier, blasts the loudspeakers, and paradoxically enough, becomes unintelligible to the audience.

All of these conditions tend to hinder instead of help users of P.A. equipment—and accounts in a large degree for the reluctance of many potential users to purchase or rent P.A. systems.

When one stops to consider how an Audio Automatic Volume Control (or "Automatic Constant Output") or "A.A.V.C." system would keep the volume at some pre-determined pleasant level regardless of how far from, or close to, the microphone the orator stood, or how loud, or low, he spoke, one can hardly believe that this valuable adjunct has been omitted from nearly all commercial amplifiers available today.

The all-purpose mobile amplifier (Fig. A) which was specifically developed for electioneering purposes incorporates a practical A.A.V.C. circuit as diagrammed in Fig. 1.

THE "A.A.V.C." CIRCUIT

The A.A.V.C. circuit functions as follows. A capacity, C1 and C2 and a resistance, bleeder system R1, R2, R3, R4, is inserted across the output circuit of the 6L6 beam-power output tubes and tapped at the electrically balanced points X and Y, to bring off a suitable A.C. voltage, so that when full power output is attained, the peak voltage applied across the cathodes of the A.A.V.C. type 6H6 tube is sufficiently high to cause a rectified voltage of some pre-determined magnitude to appear across load resistor R6 in the plate circuit. This voltage is negative in respect to ground and is then fed through the time-delay resistor-condenser combination, R7-C3, into the sharp cut-off grid, G3, of the 6L7. The no-signal bias of this grid is such that the G1-plate transconductance of the 6L7 is high (over 1,000 micromhos). When the output level of the 6L6 power output stage reaches 32 W. the rectified voltage fed to G3 decreases the transconductance and the gain, of the 6L7. An auxiliary control (A.A.V.C.) biases the cathode of the 6H6 positively or negatively with respect to ground so that rectification takes place at any desired output level (from 1 to 50 W. peak).

In order not to upset speech inflections and intonations, the time constant of the G3 control-grid voltage circuit is adjusted to respond only to those voltage variations which persist for 0.25-sec. or more. A more rapid fluctuation of volume adjustments would destroy desirable characteristics of the individual's speech.

THE VOLUME EXPANDER CIRCUIT

Naturally, A.A.V.C. is entirely undesirable for the reproduction of recorded music. For this reason, a changeover switch is provided for volume expansion, so that phono. records may be reproduced with exaggerated volume accentuations to compensate for the compression which takes place during the recording process. This expansion switch obviates the necessity of using an additional 6L7 for volume expansion, as the same tube can be used for A.A.V.C. and A.V.E. (Automatic Volume Expansion).

A separate 6H6 rectifier and 6C5 voltage amplifier are required however, so as to alter the bias of the G3 grid of the 6L7 to produce a low G1-plate transconductance with no-signal, and a high G1-plate transconductance with applied signal.

THE POWER SUPPLY

As the mobile amplifier was designed for automotive use, it has been equipped with a special dynamotor-type power supply capable of producing 450 V. at 200 ma. which is more than adequate for the plate and grid voltage requirements of the amplifier. For 110 V. A.C. operation, a suitable power supply may be substituted for the dynamotor. For universal operation from 110 V. A.C. and 6 V. D.C. a "chopper"-type power supply may be employed as described in the September issue of Radio-Craft, page 141.

The author will be pleased to answer all questions relative to this new type of amplifier. Address all correspondence care of Radio-Craft.

This article has been prepared from data supplied by courtesy of Amplifier Co. of America.

EVERY RADIO SERVICEMAN SHOULD OWN



Pocket D.C. Volt-Ohm-Milliammeter

FREE THE NATIONAL UNION WAY



*The National Union Way makes the purchase of National Union radio tubes doubly profitable. Besides full protection on the highest quality radio tubes, each National Union tube purchased helps to earn free equipment. But, possession of the equipment is obtained at once with just a nominal cash deposit. (Deposit is rebated when required number of tubes have been purchased). Over 50,000 completed deals with progressive radio dealers. Don't be misled. See your National Union jobber and get all the facts.

OTHER NATIONAL UNION OFFERS

In SOUND EQUIPMENT items available include 17-watt portable system, 10-watt portable system, 6-watt portable system, phonograph pickup and turntable, etc.

NATIONAL UNION

In SERVICE EQUIPMENT items available include tube testers, analyzers, oscillographs, signal generators, modulators, meters, etc. In SHOP EQUIPMENT items available include stock cabinets, coats, display signs, etc. All items absolutely free the National Union Way.

NATIONAL UNION RADIO TUBES

National Union manufactures a complete line of radio tubes in glass, metal and G-type. Na-

Reads D.C. 15-150-750 volts at 1000 ohms per volt; 1.5-15-150 Milliampers; 1/2-1000 low ohms; 0-100,000 high ohms at 1.5 volts.

tional Union's high quality has made them the outstanding favorite in the radio service profession. All sales policies have been formulated with the idea of making National Union radio tubes the ideal replacement tube for the radio dealer. This has been backed up with a selling program that means real support and help to the wide-awake dealer. Dealers and jobbers handling National Union radio tubes are the leaders in repair parts and service.

Let National Union Help You

THE ROAD TO BETTER BUSINESS

1. Full guarantee on highest quality radio tubes. 2. Cut price business not solicited. 3. Price Protection.

4. N.U. jobber stocks are complete...No hunting for odd types. 5. Timely business building aids.

Write for Information

National Union Radio Corporation RC1136
570 Lexington Ave., New York City
Please send me more information on Ranger Examiner New Pocket D.C. Volt-Ohm-Milliammeter.

Dealer's Name

Address

City State.....

AM-5 P.A. AMPLIFIER



An unusually powerful, hi-fidelity amplifier at a price which you cannot afford to miss. Uses 57-2B6-5Z3 tubes in a simple and foolproof circuit which will give years of dependable service. Overall gain 75 db. Power output 5 watts. (7 watt peak.) Built-in hum-free power supply. Input impedance 500,000 ohms. Output impedance from plate of 2B6 is 5000 ohms. Heavy Black great beauty. **SOLD ON**

shrivel finished metal chassis of MONEY BACK GUARANTEE. Ready to use, less tubes.....Price **\$7.25** ARCTURUS tubes, extra, \$2.95 Send for Free P.A. catalogue No. 127 **PRECISION SOUND LABORATORIES** 126 Liberty St., New York, N. Y.

New **SOLAR**
MADE IN U.S.A. PATENTED DESIGN

Molded Bakelite... **"DOMINO"** paper condensers

Small, flat, easy to use, better in appearance! Heat- and moisture-resistant! Wide range of capacities! Permanent capacity! Full voltage protection! 10 in standard carton... COMPARE!

SOLAR MFG. CORP.
559-601 Broadway, New York City.

Please Say That You Saw It in RADIO-CRAFT

★★★ HERE IS A SCOOP!! ★★★



26-WATT UNIVERSAL 110 volt AC and 6 volt DC CONVERTIBLE AMPLIFIER— ESPECIALLY DESIGNED FOR ELECTIONEERING.

ENTIRELY SELF-CONTAINED 110 volt AC power supply, and 6 volt DC GENEMOTOR— ON SAME CHASSIS!

- The following specifications illustrate the outstanding features of this amplifier:—
- * Uses 6 tubes glass or metal.
 - * Metal: 1-6J7, 3-6N7, 1-6F6, 1-83.
 - * Glass: 1-6CG, 3-6AG, 1-42, 1-83.
 - * Overall gain 112 DB.
 - * 26 watts output—35 Watts Peak.
 - * 2 position electronic mixer.
 - * 2 channel input—1 high gain, 1 medium gain.
 - * Input for: Crystal or Velocity microphones and phonograph pickup.
 - * Built in field supply for 2 speakers.
 - * Calibrated feedback suppressor.
 - * Output tapped at 2-4-8-15-500 ohms.
 - * Stand-by switch with 2 indicating pilot lights.
 - * Connections through standard plugs.
 - * Instantaneous voltage changeover made by toggle switch.

Chassis Size: 16" x 8" x 9"
 Completely Wired and Tested
 NET PRICE **\$33.50** Less Tubes

Write for free catalogue, or our Mr. Werner for engineering advice. Give full details.

AMPLITONE PRODUCTS CO., 135 Liberty St., N. Y. C.

Federal Trade Commission Bars Unauthorized Use of Well-Known Radio Names

In the following cases several unauthorized manufacturers were directed to discontinue use of the words or symbols "Edison," "Bell," "Brunswick," "Bronswick," "Victor," "Marconi," "Radio Corporation of America," "General Electric," "R.C.A.," "R.S.A.," "R.C.I.," or "E.B.," on escutcheon plates, in brands, or in trade names or in any other manner, that the radio sets and appliances sold by respondents are the radio sets and appliances manufactured, assembled, or sponsored by Thomas A. Edison, Thomas A. Edison, Inc., A. T. and T. Co., W. E. Co., Marconi Wireless Telegraph Co. of America, Radio Corp. of America, Victor Talking Machine Co., Brunswick-Balke-Collender Co., Warner Brothers Pictures, Inc., Brunswick Radio Corp., Grigsby-Grunow Co., or G. E. Co.

POWERTONE

Model 801—Pocket Volt-Ohmmeter

A sensitive, compact and accurate volt-ohmmeter that will be the busiest instrument in your "lab." or out on jobs. DC voltage readings—0.5-50-100 and 1000. Resistance readings from 1/2 to 500 and 200 to 200,000 ohms. Will read from 0 to 1 MΩ. Low resistance range direct reading. Meter has 1000 ohm per volt sensitivity. Battery is self contained. Panel is clearly lettered. Compensator provided for zero adjustment. Complete with test prods. Measures only 5" x 3 1/4" x 2 3/4". Your price complete with battery.



\$5.75

JOBBER'S WRITE IN FOR PROPOSITION

POWERTONE ELECTRIC CORP.
 179 Greenwich Street New York City

Distributor
TRY-MO RADIO CO., Inc.
 85 Cortlandt St. New York City

LOOKING AHEAD IN THE RADIO FIELD

(Continued from page 267)

Increasing use of modern developments by criminals today makes it essential that police departments all over the country utilize radio to facilitate detection and prevention of crime.

RCA recently demonstrated before a distinguished group of 400 enforcement officers from all over the country, the use of talkies to afford positive identification of criminals. Governor Hoffman and Colonel H. Norman Schwarzkopf, New Jersey Police, sponsored the demonstration, at Trenton, N. J. A centralized motion picture filing bureau under Federal auspices may soon be set up, as a result of this conference, as a central reference for the 16-mm. and 35-mm. talkie film. A typical sound equipment set-up of the type employed in the demonstration includes the following apparatus: 2 microphones, control panel, amplifier and its current supply unit, and a recorder and camera. Station houses throughout the country employing this system would require very similar equipment. Several thousand communities are in position to use this sort of apparatus—and the installation and service work would absorb hundreds of radio men.

Doctor J. M. Dellinger, of the National Bureau of Standards, and representative of the government's Interdepartment Radio Advisory Committee, asked that of the 1,907 frequencies assignable in the range between 30 and 200 megacycles, 1,012 be set aside for government use and 895 for non-government services. Although this request for 60 per cent of the available channels might appear to be based on a "nothing ventured, nothing gained" viewpoint, let us see just what services Uncle Sam plans to expand, and whether these might perhaps have commercial applications that would utilize radio men not connected with any government enterprises.

Although some portable services at present require frequency separations of 1 per cent and more at 30 megacycles, it is feasible to limit the separation to 0.1-per cent in equipment that may be constructed and operated at closer tolerances; in the latter instance, then, calculation shows that a total of 1,907 such channels are assignable between the limits of 30 and 200 mcs. (1,210 between 30 and 100 mcs., and 697 between 100 and 200 mcs.), and until equipment is sufficiently perfected in a given service for operation at 0.1-per cent separation, a sufficient number of channels can be assigned to the service to secure satisfactory results.

The United States Government has found the specified range "valuable for many government purposes. To mention merely a few examples these have included such purposes as law enforcement, aids to air and water navigation, military applications, forest fire protection, weather predicting, and various short-distance communication services."

A goodly portion of the 6,800,000 farms in the United States, of which only about 2,500,000 have radio sets, will be benefited when Uncle Sam's REA cornucopia spews \$4,500,000 into rural electrification of 12 States, starting this fall. (In case you don't recall—"REA" is short for Rural Electrification Administration.) Electric sets will be joggled up in the districts these power lines service, in preference to battery-powered receivers—and even present owners of battery sets will in many instances

swing over to a new electric set. Programs of interest to these districts are already available from hundreds of stations, according to surveys that have been made by the Administration. Here is where the wide-awake radio man, with a car at his disposal, will have the chance of a lifetime to "clean up." Here's another angle to keep an eye out for: the educational possibilities of radio in rural schools. (The opportunities in this direction for an up-'n'-coming radio man are very great.)

"The Future of Radio," a paper read by David Sarnoff, President of RCA, contains information of importance to the foresighted radio man.

Said Mr. Sarnoff, "—Radio has made possible outstanding progress in mass communication. Ample allocation should be made for the greatest use of this public service for the broadcasting of sight as well as of sound, nationally and internationally." (The italics are ours.)

Continued this paper, "—mastery of the ultra-high frequencies . . . is bringing television and facsimile within the area of practical use. —higher regions of the spectrum which only yesterday constituted a 'radio desert' are now being made fruitful. This expansion of the useful radio spectrum has only begun. Beyond the ultra-high frequencies lie the 'micro-waves'—frequencies that oscillate at the rate of a billion cycles a second, wavelengths measured in centimeters instead of meters.

"Future developments in micro-waves may well prove revolutionary." Usable channels then will be numbered in the millions, instead of a few scant thousands as now. "—there will be frequencies enough to make possible . . . not only an unlimited array of mass communication services, but of an unlimited number of individual communication connections. In that day each one of our millions of citizens may have his own assigned frequency to use wherever he may be."

Said this young executive, "—We deal in radio with a public treasure that . . . is unlimited in its extent. The frequencies which make up the radio spectrum constitute one of the nation's most valuable natural resources. Each of them must be made to yield its maximum of service under the stimulation of every new discovery."

In the course of his talk, Mr. Sarnoff (who started in radio "way back when"—, as a ship's operator) made this roseate remark (which we have italicized):

"—never before have I seen so many developments emerging into practical achievement as the laboratories promise at this moment."

Radio Marine Corp. of America has just announced the availability of "harbor-phone" equipment to use in service with towboats, pilot boats and other harbor craft for 1-way shore to ship service; orders are given or countermanded from the shore station, without need for any "received OK" return signal, with "100 per cent reliability over the range of New York Harbor." Bridges do not affect the 100-W., 17-meter signals. The receiver aboard ship, pre-set on the frequency of the transmitter, is equipped with a "squench" circuit that maintains the receiver "dead" until the shore transmitter comes on the air. The transmitter carrier current then automatically cuts the receiver into action. The N. Y. Telephone Co. on almost the same day announced a new 2-way ship and shore radio telephone "pay station" service; the equip-

INVESTIGATE THE Magic Magnet Speaker

Write today for complete technical data on the Cinaudagraph Magic Magnet Speaker Eight, Ten, Twelve and Eighteen Inch line.

CINAUDAGRAPH CORPORATION
 DEPT. R C STAMFORD, CONN.

RADIOS SAVE UP TO 50%

ALL NEW 1937 MODELS

A penny post card brings you our new, full size or 16-page BARGAIN CATALOG free. Many models to choose from: 4 to 10 tubes; AC-DC, All-Wave and new Field sets that operate like city radios; Send post card or coupon below for full details of 30-day no-risk trial and \$5.98 proposition. Write now!

30-DAY NO-RISK TRIAL

Enjoy it a month, then decide. Write!

MAIL COUPON Free Catalog

GOLDENTONE RADIO CO., Dept. B, DEARBORN, MICH. Without obligation, send me new 1937 Catalog and 30-day trial plan.
 Name _____
 Address _____

Please Say That You Saw It in RADIO-CRAFT

ment is suitable for all harbor craft. Calls, made through the regular telephone exchange on shore, register aboard ship by ringing a bell in the orthodox manner. The 5-W. transmitter operates on 2 to 7 meters. (The FCC regulations permit operation of low-power radio phone apparatus, on ships not compulsorily equipped, by persons holding a Radio Telephone 3rd-Class Telephone Operator's License—a simple permit which doesn't require even a knowledge of the telegraph code!) These services by RMCA and N. Y. Tel. Co., if also put into operation on the Great Lakes and along the entire U. S. seacoast, will require many radio men for installation and maintenance work.

The Radio Manufacturers' Assoc. ("RMA") had their "day in court"—and (justly enough) several times. Some of the statements by James M. Skinner, Chairman of this organization, are full of import for the radio man who is wise enough to read between the lines.

Television was discussed on the basis of a "3-point program" planned to establish uniformity in technique and equipment, with a view to nationwide coverage—and the goal, a single television system for the United States, with every receiver capable of receiving every broadcast reaching its locality.

Said Mr. Skinner, "The Radio Manufacturers' Assoc. views television ultimately as a big business, a business which will employ many thousands of people in the production and operation of broadcasting equipment, in the production of receiving sets, in the production of daily programs, and in the fields of distribution and service. Television, we believe, is one of the new businesses the country needs to create new jobs." (This opinion was repeated later in the week by Albert F. Murray, also representing RMA.)

OPERATING NOTES

(Continued from page 281)

determine whether or not an audio transformer is causing a lot of unnecessary "static" without removing same, shunt each winding in turn with a resistor having about half the resistance in ohms as the winding itself. If this is the source of the noise the frying and crackling will cease immediately. Also check the wave-change switch.

VICTOR I. DUDLEY

NEWEST DEVELOPMENTS IN BEAM-TUBE INPUT AND OUTPUT TRANSFORMERS

(Continued from page 278)

secondary windings, or that resistance coupling is employed. Naturally, only a limited amount of power can be obtained from the 6L6 tubes if resistance coupling or an ordinary input transformer is used.

A better method is to tap the output transformer at about 10 per cent from the "B" plus end and bring the voltage from this point through a condenser to the control-grid return of the corresponding tube, as shown in Fig. 1B.

The best method if large power outputs are involved, as pointed out later, is to use an output transformer with a separate feedback winding as shown in Fig. 1C.

DESIGN THEORY

To understand the above statement better, reference should be taken to the design of the input transformer. In order to obtain the greatest power output from the 6L6 tubes, it is of primary importance that D.C. resistance in the control-grid circuit of the 6L6 tubes should be no more than a few hundred ohms, and that the input transformer has a stepdown ratio (which depends upon the driver tubes employed, and should be about 2½:1, when two 6C5 or equivalent tubes are used as drivers). In this case, if a primary impedance of 5,000 ohms is assumed for a tube, then the secondary impedance would be in the neighborhood of 10,000 ohms. If, now, a load is inserted into each grid-return varying from about 200 ohms to 5,000 ohms, it will have quite an irregular effect on the performance of the output tubes. If the feedback system of Fig. 1B is analyzed (see Fig. 1D), it will be found that the grid-return resistor, R, is paralleled by a total equivalent impedance varying from 200 ohms up to about 1,200 ohms due to the change in impedance of the coupling condenser, C, with frequency. In other words, the grid-return im-

DOWN GO YOUR COSTS UP. GO YOUR PROFITS

\$38.95

Complete Ready to use



MODEL 5143

Weight 8 lbs.

Size 11½" x 10½" x 5¼"

When you use a **DEPENDABLE Master Analyzer**

—a whole service shop in one instrument for only \$38.95

No other analyzer, regardless of price, contains so many engineering features and advantages.

The most improved Analyzer on the market

41 ranges — measures AC and DC *Micro-amperes*, Milliamperes and *Amperes*, ohms ¼ to 40 megohms, capacity .0001 to 300 mfd., AC and DC volts 0.1 to 1,000 volts, power level in DB -15 to +40 and *Inductance* in Millihenries 25 to 1,000 and in Henries 0 to 10,000.

Our new, superior method of making A.C. measurements (our own invention) in this instrument makes copper oxide rectifier instruments obsolete.

See your jobber today, or write direct to factory.

Ask for our free attractive catalog describing the latest developments in radio service instruments.

Write today to Dept. C-11 for the newest circular on the latest Tube Tester and the improved Cathode Ray Oscilloscope.

RADIO CITY PRODUCTS CO.
88 PARK PLACE NEW YORK CITY "DEPEND ON DEPENDABLE"

BIRNBACH

No. 375 ALL-WAVE ANTENNA

Easily Installed . . . Reduces Static

COMPLETE KIT

\$4.25 List

Cat. No. 376 (Less Coupler)

\$3.50 List



Connected and soldered at the factory, this antenna kit eliminates guess work on your part, and may be easily installed by the layman. Thousands are in use, and they have given complete satisfaction. Kit consists of—2 coils of aerial wire, antenna transformer, receiver coupler, porcelain knobs and insulators, lead-in strips, ground clamp and instruction sheet. Ask your favorite dealer to show it to you.

BIRNBACH RADIO CO.
145 Hudson St., New York, N. Y.



UNIVERSAL 5-METER HAND SET

A new, 15 ounce, compact hand set—Designed for 5 meter transmitters and 5 meter transceivers—Highly polished, moulded bakelite units—75 or 2000 ohm uni-polar receiver—High output, single-button Universal microphone of 200 ohms—6-ft. 4-conductor cord with color-coded phone tips—List Price, Single-Button microphone \$8.00.

UNIVERSAL MICROPHONE CO., Ltd.
424 Warren Lane, Inglewood, Calif., U.S.A.

Please Say That You Saw It in RADIO-CRAFT

New TURRET TOP ANTENNA CREATES SENSATION IN Performance and Style

It's new, efficient, stylish and streamlined. Designed especially for Turret Top cars. No holes to drill . . . Increases pickup in isolated districts. Low motor noise level obtained by shielding effect of car top. Will not short out from ice, water or mud. Works well anywhere all the time. Insures more distance, less noise and more volume. Mounts on rubber vacuum cup standoffs; adds to streamline appearance. Works equally well on fabric top cars. Easily and quickly installed. Write for information.

**NORWEST
STREAMLINE[®]
AUTO ANTENNA**
TRADE MARK REG.
PAT. PENDING, U. S. & CANADA

SOLD BY LEADING JOBBERS EVERYWHERE

New Low {
Sedan or Coach **\$5.50**
Coupe **\$5.00**

NORWEST RADIO LABORATORIES

3454 FULLERTON AVE. Dept. 115, CHICAGO, Ill.

Western Division Shelby, Montana



IT SELLS AND IT SATISFIES

ALL PURPOSE MOTO-TOOL

10 DAY MONEY BACK TRIAL

Grinds, drills, engraves, routs, carves, and does many other slow hand jobs for home, school or shop. Strong, powerful, yet handles as lightly as a pencil. Weighs 9 oz. Fits in any light socket. A.C. or D.C. 110 V. universal motor. About 18,000 R.P.M. Efficiently cooled. Universal collet chuck. Oilless self-aligning ball thrust bearings. Order on 10 day money back trial or send for free Moto-Tool booklet.

UTILITY TOOL SET of 20 general accessories for all types of Moto-Tool work. \$5.75.

DREMEL MFG. CO.
4511-Ct RACINE, WIS.

ONLY \$9.85
SENT POST PAID

SERVICEMEN

Look up Oct. '35 RADIO-CRAFT page 215

We have all genuine parts for this **ALL-WAVE SERVICE OSCILLATOR**

Write for price sheet of complete parts for the new companion instrument to the above—the "WHEATSTONE BRIDGE CAPACITY ANALYZER" as described in September '36 Radio-Craft.

Headquarters for Parts—Since 1923
THE RADIO MAN, Inc.
2127 Greenwich St., New York, N.Y.
NO CATALOGUE—BUT LOWEST PRICES

Learn TALKING PICTURE PROJECTION SOUND RECORDING TELEVISION-RADIO

Qualify for Good Jobs

Learn in Los Angeles. Practical instruction. Newest equipment. Master training courses. 30,000 graduates. Earn room and board while learning. Coach R. R. fare allowed to L. A. Send coupon for Catalogue.

NATIONAL SCHOOLS—LOS ANGELES

NATIONAL SCHOOLS—Los Angeles
Dept. RC-11, 4000 S. Figueroa St.

Name age

Address

City State

HOW TO IMPROVE "TALKIES" FIDELITY

(Continued from page 286)

the input of V1. The use of parallel plate feed has become quite general on extended-frequency systems and may become even more so in the future except for one thing. High-grade transformers used in this type of work have cores which are made of the best grades of steel. This results in unusually good frequency characteristics and a high overload point. Due to the high saturation point, it is not necessary, under normal conditions, to employ parallel plate feed. Transformers of this type are practically unaffected by mechanical shock and heavy direct current though the windings will not permanently magnetize their cores. This means that these transformers will retain their characteristics for years of use. These are important factors which should be considered in choosing types of coupling for high-quality A.F. transmission and amplifier systems such as these which the service engineer will encounter.

POWER AMPLIFIERS

The point has been reached where the sole factor governing the frequency response of matching and amplification equipment is the fidelity of the transformers used. The object of this development was the production of ideal amplifiers through the use of extended-frequency transformers. Several companies have done exceptional work in this field and the author has often been privileged to consult their engineers on these problems. The S.O.S. corp., whose article on wide-fidelity lenses appeared in an earlier issue, has been of assistance in supplying data on the optical system.

The requirements of a good power amplifier are:

- (1) Uniform frequency response over the entire audio range.
- (2) Negligible waveform distortion.
- (3) The elimination of hum and extraneous noise.
- (4) High efficiency.
- (5) Well shielded.
- (6) Positive reliability.
- (7) Flexibility.

It is at once obvious that the clue to all of this lies in using correct transformers. There are only a few difficulties to be confronted in replacing transformers: proper position for minimum outside noise pick-up; physical fitting of the transformer in place; selection of the proper impedance-matching transformer; and a little care in placing of leads to the transformer.

Figure 4A is a circuit improved by the author. Audio transformers were replaced with other types for the same purpose. In resistance-capacity coupling we recommend a 0.1-mf. coupling condenser and for grid and plate resistors you should consult the manufacturer's data on the tube.

Figure 4B is an extended-frequency amplifier of a type that is gaining much favor. To use fixed-bias, R10 is shorted out and the center-tap of the 2A3 filament is returned to ground. Filament winding AA is used only for the type R2 rectifier filament. With self bias, maximum undistorted output is 10 watts. With fixed bias, this may be increased to 15 watts. Note that a separate power supply is used when self-bias is not used.

System A (Fig. 4C) uses this modified amplifier on wide-range installations and the original amplifier is known all over the world for its reliability. Modification included the use of type 264A tubes in place of 239A, since the former type has a greater amplification factor. The transformers were replaced with ones having wider frequency range.

Figure 4D shows a high-fidelity power amplifier used by system B. The types 56 and 45 tubes are part of the voltage amplifier—the 50s being in the power stage.

In the runs back stage, 15-ohm lines are very common in talkie systems. 500-ohm lines, due to some loss, have been frowned on, since a separate winding is required for the monitor, and they are not often met with on the commercial systems, A and B.

Part III of this series will cover the important subjects of loudspeaker installations and the control of acoustics in theatres and auditoriums.

Westinghouse Power Generator

Manufactured for U. S. Signal Corps.
200 Watt 110 V. AC

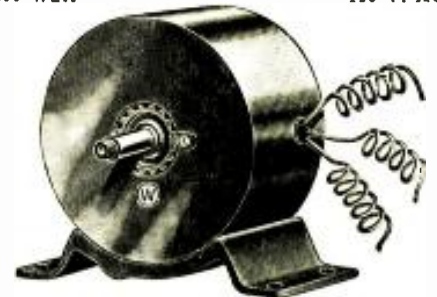

A. C. ELECTRICAL POWER

from a Windmill, from available Waterpower, from your Automobile, from your Motorcycle, from your Bicycle. Foot-pedals or Handcrank; operates A.C. Radio Sets in D.C. districts, also A.C. Radio Sets from 32 V. D.C. furin light systems; use two Generators in series to get 200 V. A.C. Used as an A.C. Dynamo, lights ten 20 Watt 110 Volt lamps; Short Wave Transmitter supplying 110 Volts A.C. for operating "Ham" Sets; Motor Generator; Public Address Systems; Camp lighting; etc., etc.

There Are Over 25 Applications

Specifications:
HOUSING—Aluminum (Diameter 6 1/4 in. Length—5 1/4 in.). SHAFT—2 3/16 in. (driving end). Diameter—9/16 in. (the end is threaded for a distance of 1/4 in.). BASE—Cast iron (Length—7 3/4 in. Height 1 9/16 in. Width 4 3/4 in.). OUTPUT—200 Watt 110 volts AC (speed 4500 R.P.M.). STATORS—Two pairs (two North and two South). ROTOR—12 tooth inductor. Built-in commutator. Rotor turns in ballbearings. 1/4 to 1/2 H.P. needed to run generator.
BLUE-PRINT 22 x 28 in. and Four-Page 8 1/2 x 12 in. Applications and INSTRUCTION SHEETS FREE with Generator.
Generator, as described, including four replacement carbon brushes. Blue-print and instructions **\$7.90**
Send \$2.00 deposit, balance C.O.D. Shipping weight 18 lbs.
(Replacement carbon brushes bought separate \$1.50 per set or four. Set of instructions bought separate \$1.00.)

ONLY \$4.96 U. S. NAVY AIRPLANE-TYPE Microphone and Receiver

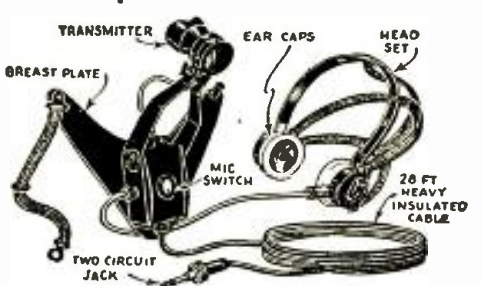

THIS Microphone and telephone headset outfit was built especially for the U. S. Navy Aviation Corps for Plane-to-Plane and Plane-to-Ground communication. The Holtzner-Rabot Electric Company constructed the outfit to Government specifications and under rigid Navy Department supervision. The outfit consists of a low-impedance carbon microphone (transmitter), securely fastened to a metal breast-plate, and a set of heavy-duty, low-impedance earphones. A specially constructed switch on the back of the breast-plate controls the microphone circuit. The earphones are U.S.N. Utah type, attached to adjustable headband. Twenty-eight feet of very heavy weather and waterproof conductor cable, terminating in a special brass plug, is furnished with this complete outfit. Current of not more than 10 volts should be used. A storage battery is the most satisfactory current supply. Talk in a natural tone of voice, when using the outfit, with the lips close to the mouthpiece. Shouting and loud talking should be avoided. We understand that the U.S. Government paid more than \$40.00 for each of these outfits. We have bought the whole lot at a low price and are offering them, as long as the supply lasts, at \$4.96 each, complete as shown in illustration. The shipping weight is 9 lbs.

All merchandise in original packages—never used. Money-back guarantee.

All Shipments will be forwarded by Express Collect if not sufficient postage included.

WELLWORTH TRADING CO.
560 W. Washington Blvd., Dept. RC-1136, Chicago, Ill.

THE BEGINNER IN PUBLIC ADDRESS

(Continued from page 287)

method is the most simple of those commonly used and offers a very convenient means of sound distribution when portability and simplicity of installation are of major importance. Generally 1 or 2 loudspeakers are utilized, and so placed as to give best coverage and the least amount of feedback. If the area to be covered is relatively large, then the speaker units must be operated at high volume level in order to force the sound to the most distant parts. The result is that the sound will be uncomfortably loud to those nearest the speakers and possibly inaudible to those farthest away. Due to the high level of the sound, feedback is usually quite bad but can generally be reduced to the required minimum by placing the reproducers in proper positions at a distance of about 50 ft. from the microphone.

Baffle Requirements. The most suitable baffles for speakers of this type are those of the sound-projecting type having enclosed speaker housings so that the sound is projected only from the front and in a direction away from the microphone. Parabolic deflector horns as well as directional and flare-type baffles are ideal for such installations.

Sound Distribution by Many Loudspeakers. In all types of sound installations, equipoise of sound (not loudness), should be the goal. An ideal sound installation is one whereby each and every one in the audience can hear distinctly and yet be unaware of the fact they are listening to amplified sound. This requires a number of loudspeakers properly placed in the area to be covered. In this manner each speaker unit will serve only a portion of the total area and may, therefore, be operated at comparatively low volume level. In addition to better coverage, this method does not detract the listeners' attention from the program. The low volume at which the speakers operate is in most cases insufficient to cause feedback under normal conditions, even with a sensitive microphone in the same room. The number of speakers required for an installation of this type depends on the acoustics of the room, and its dimensions and seating capacity. Rooms having bare walls, with little or nothing to absorb or cushion the sound waves when they strike a reflecting surface, are likely to require more reproducers, for satisfactory performance, than a room which has been acoustically treated. A treated room may be considered as one whose walls have been partially or totally covered with drapes, curtains or other anti-echo materials so as to reduce echo (reverberation) to the desired minimum. The value of a sound system is no longer judged by its ability to "burst ear drums" as in the earlier days, but by its ability to give complete coverage at comfortable volume to all. Use plenty loudspeakers—you can not have too many.

This article has been prepared from data supplied by courtesy of Burnstein-Appelbee Co.

STREAMLINED MIKE IS ALSO A LOUDSPEAKER!

(Continued from page 272)

ELECTRICAL CHARACTERISTICS

Perhaps the most outstanding characteristic of this transducer is its efficiency. Operating as a microphone, it develops approximately 45 per cent electrical energy against sound input, as compared with 1 to 10 per cent for other types of microphones. Approximately the same efficiency percentage of sound output with electrical input, when used as a loudspeaker, is secured.

This microphone may be operated in any position or angle. The directivity of the unit is indicated in the graph, Fig. 1A. The streamline housing reduces feedback tendencies almost to the vanishing point, and when used outdoors the same design characteristic eliminates the need for wind screens.

As shown in Table I the sensitivity of the new microphone is extremely high, so that for distances up to 500 ft. it is possible to hold a 2-way conversation without recourse to amplification! This idea is illustrated in Fig. E.

TABLE I
Output Level In Decibels
0 db. = 12½ milliwatts for sound pressure of 10 bars

Condenser	-70 to -75
Crystal	-65 to -75
Velocity	-60 to -70
Dynamic	-50 to -65
Carbon	-35 to -40
The new "Bullet"	-35 to -40

The new transducer's characteristics as a microphone recommend the instrument for use in public address work, sound reinforcement, recording systems, amateur radio communication, inter-office phones and experimental work.

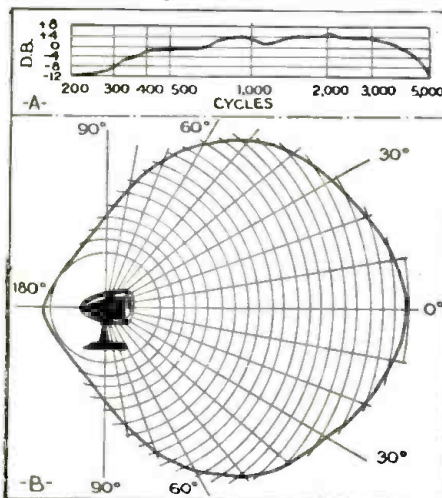
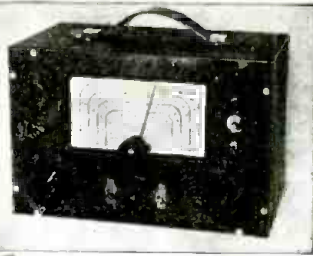

Fig. 1. Frequency response and directivity.

Please Say That You Saw It in RADIO-CRAFT

TWO SUPERIOR LEADERS!

» They defy all COMPETITION.
» Almost one thousand sold in five months. » They must be good!



PRECISION CONDENSER ANALYZER

Output Meter—Leakage Tester

AN AMAZING PRICE on a new instrument that every service man and home experimenter needs. Not an approximate meter reading but a true capacity bridge that is

DIRECT READING up to 16 mf.

Tells Everything You Want To Know About a Condenser

• Is it shorted or open circuited? • Does it leak and how badly? • What is its capacity?

THEN throw a switch and you have a sensitive output meter with shunt voltage adjustment for use with your oscillator when lining up receivers.

Three instruments that are indispensable to every serviceman; combined in one small portable case and operating directly from the 110 volt A.C. line.

Model 40 Capacity Analyzer, in shielded cabinet with carrying handle, wired, calibrated and tested. (Shipping weight 7 lbs.)

\$7.40
Complete with 2 tubes

A NEW SIGNAL GENERATOR THAT DOES EVERYTHING

R.F. coverage 100 kc. to 20 mc. all on fundamental. Dial is direct reading in frequencies. Modulated at 1000 cycles, included or excluded by front panel switch.

R.F. output may be taken from high or low impedance post. Separate audio output, A.C. or D.C. operation.

Two extra posts on front panel enable leakage tests for condensers, tube and other high resistance circuits otherwise difficult to test.

Model T-37, wired, calibrated, tested; complete with three tubes in shielded cabinet with carrying handle and instructions (shipping weight 7 lbs.)

\$12.40

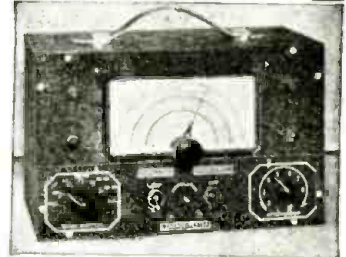

SUPERIOR INSTRUMENTS COMPANY,

139 CEDAR STREET
Dept. T-101
NEW YORK, N.Y.

6-VOLT ELECTION SPECIAL

8-Watt Public Address System

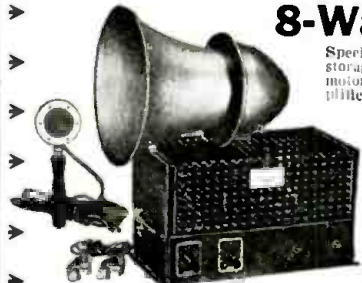

Specially designed for sound trucks. Requires but a 6-volt storage battery (car battery) for operation. Built in dynamotor supplies all "B" voltages. 8-watt high-gain amplifier with electron mixing for crystal mike and phonopickup. Will cover a radius of 1200 ft. in the open. Has plugs for two speakers and separate controls for two input channels. Built on heavy steel chassis with protective steel screen. Tubes: 25, 75, 6A6, 6B5, 84. Amplifier alone, less tubes, \$23.50; Hand-Crystal Mike, \$12.95; Aluminum Projector Horns, \$4.45 ea.; Rola 10" Hi-Fi Speakers for Horns, \$4.45 ea.; Kit of Matched Tubes for Amplifier, \$4.95.

Order direct from this ad. Send for FREE P.A. Bulletin.

Peerless Sound Labs.

80 Eighth Avenue

New York City

only
\$23.50
Amplifier
less tubes

Memo...
Will start this season right by modernizing my tube checker and set analyzer with "Precision" ... will write for details ... must remember to mention make and model number of my instruments. — will write to

PRECISION

APPARATUS CORPORATION
821 EAST NEW YORK AV., BROOKLYN, N. Y.

RADIO REPAIR CEMENT

"THE ORIGINAL SPEAKER CEMENT"
Used for replacing speaker cones, mending old, rattling, or torn cones, sealing adjustments, cementing loose tube bases, grid caps, coils, leads etc. Dries fast. Vibration proof, waterproof. Invaluable also to Service Men. See your jobber, if he cannot supply you, write us. List price 50c for large bottle. Send for FREE circular of complete line. GENERAL CEMENT MFG. CO. (Radio Div.) Rockford, Illinois



CISIN'S SENSATIONAL
New Magic Electronic Eye

"TEST-ALL"

\$2.95



Complete Kit of Parts with Crackle Finish Metal Cabinet, Aluminum Shield, Diagram and Detailed Instructions.

Pat Pending U. S. Serial No. 492,576

FOR SERVICEMEN and EXPERIMENTERS

A Hundred-in-One Service Instrument. Tests open-circuits, leakages, Tuning Indicator any type Radio. Lines up r.f. and i.f. stages. As Vacuum Tube Voltmeter measures output, a.c. and d.c. voltages. Measures and compares resistances and capacitance. Self-contained a.c.-d.c. power supply.

Kit of Matched Tubes (2 Metal Tubes, 1 Magic Eye) \$3.05

H. G. CISIN, Chief Engineer
ALLIED ENG. INSTITUTE
Dept. RC-3,-98 Park Place, New York, N. Y.

ONLY \$2.50

New Authorized TELEVISION BOOK



Strips the Mystery from the World's Newest Science. Gives Money-Making Facts. Just published. Covers Electronic Television in simplified non-technical way. Gives all information about methods, apparatus, wiring diagrams, etc., including cathode ray, kinescope, kinescope, and other recent inventions. Authorized by R. C. A. and Farnsworth, the two leaders in Electronic Television development. Positively authentic. Order ELECTRONIC TELEVISION today. Be an expert in enormous coming industry. 162 pages, flexibly bound. Illustrated throughout. Postpaid \$2.50. Money back if not satisfied.

THE GOODHEART-WILCOX COMPANY, Inc.
(Publishers of Dyke's Auto Encyclopedia)
Dept. 38 2009 Michigan Avenue, Chicago

YOURS .

for the Asking

(1)—FREE CATALOG of Condensers, Transformers, Chokes, Sockets and general equipment for receiving and transmitting.

(2)—SEND 10c for 32-page Manual of most popular Short-Wave Receivers, with illustrations, diagrams and parts lists.

Address Dept. RC-11
HAMMARLUND MANUFACTURING CO.,
424-438 W. 33rd St., New York.



Hammarlund
PRECISION PRODUCTS

SUPREME Velocity MICROPHONE



SUPREME HIGH-GAIN AMPLIFIERS

Write for descriptive literature and price sheet

SUPREME SOUND LABORATORIES
20 Liberty St., Washington Hts., Newburgh, N. Y.

RADIO ENGINEERING

RCA Institutes offers an intensive course of high standard embracing all phases of Radio. Practical training with modern equipment at New York and Chicago schools. Also specialized courses and Home Study Courses under "No obligation" plan. Catalog, Dept. RT-36.

RCA INSTITUTES, Inc.
75 Varick St., New York 1154 Merchandise Mart, Chicago
Recognized Standard in Radio Instruction Since 1919

HOW TO MAKE A DIRECT-IMPEDANCE BASS-BOOSTER

(Continued from page 289)

of hum and amplitude distortion.

In all instances, the correct setting of the booster output is that point where the voice approaches boominess, although this is of course up to the personal tastes of the listener. It will generally be found that the response curves of the various broadcasting stations vary so much that the booster control will receive constant attention. It seems that many stations have a well developed peak in the neighborhood of 100 cycles or a little lower. Unfortunately, this tends towards boominess of speech even on an amplifier having flat response in this region and forces the volume of the booster to be reduced somewhat to get away from it. On the other hand, when "playing" those stations free of excessive peaks, the booster may often be run at full gain with excellent results.

REMOVING TONE CONTROLS

When installing the booster on a radio set, some consideration should be given to tone control systems found in the average circuit. When given the depth provided by the L.F. booster, tone controls are more detrimental than ever since the loss of the higher notes, a condition generally found in these instances, becomes more prominent with respect to the balance of the music. It is just as essential to preserve the musical harmonics as it is to bring out the lows. (Indeed, the writer has found it advisable to incorporate a high-note amplifier as well as a low-note booster in the better radio receivers which he designed, to compensate for the actual transmission losses, side-band cutting and the like, under which the radio set operates.)

THE BAFFLE

The proper installation of the speaker depends entirely on the circumstances confronting the technician. In the majority of instances, the customer will probably want the entire unit placed in his present console. This can usually be accomplished without great difficulty and without changing the size of the speaker grille by adding a V-shaped false baffle behind the opening. The speakers are then mounted on the sides of the V at nearly right-angles. This expedient has been used commercially a number of times.

In console installations it is always a good plan to treat the cabinet acoustically. The writer has found that lining the cabinet with acoustical felt is of benefit. Further improvement may be had by cutting the sound compartment into oddly-shaped spaces by inserting several celotex partitions. In those instances where maximum L.F. response is desired, the technician is advised to construct a loading chamber of conventional design. The sound path should follow an exponential shape within practical limits.

As in former articles dealing with the same subject, the author is strongly in favor of using a partition of the house for the L.F. baffle area whenever possible.

LIST OF PARTS

- One Lansing chassis and cabinet;
 - *One power transformer, 700 V., C.T.; 5 V.; and 6.3 V.; 60 ma., 1-PT;
 - One Lansing choke, 300 hy., 20 ma., Ch;
 - Two Aerovox bypass cond., 0.25-mf., C1, C4;
 - Two Aerovox mica condensers, 0.01-mf., C2, C3;
 - One Aerovox shielded condenser, 1 mf., C5;
 - One Aerovox bypass condenser, 0.5-mf., C6;
 - Two Aerovox electrolytic condensers, type P-5, 8-8 mf., C7, C8;
 - One Centralab volume control with switch, 1/2-meg., R1;
 - One Centralab carbon resistor, 2,000 ohms, R2;
 - One Centralab carbon resistor, 0.1-meg., R3;
 - One Centralab carbon resistor, 0.15-meg., R4;
 - One Centralab carbon resistor, 10,000 ohms, R5;
 - One Centralab carbon resistor, 1-meg., R6;
 - One Centralab carbon resistor, 1/2-meg., R7;
 - One Centralab carbon resistor, 600 ohms, R8;
 - One Blum D.P.S.T. switch;
 - Three Wholesale Radio Service metal-tube sockets;
 - *One type 6J7 tube;
 - *One type 6F6 tube;
 - *One type 5Z4 tube;
 - One Lansing 12-in. speaker, 2,500-ohm field.
- *Name and address of manufacturer will be supplied upon request.

JOBS & CAREERS

THE VOCATIONAL DIGEST

Tells You How to Go About

WHEN YOU ARE TACKLING THE JOB OF FINDING A JOB:
WHEN YOU ARE PLANNING A CAREER:
WHEN YOU WANT TO BETTER YOUR POSITION.

On all newsstands 25c.

If your dealer cannot supply you, send a quarter and we will forward a copy at once

JOBS & CAREERS

520 N. Michigan Ave., RC-1136, Chicago, Illinois

TRY THIS DEPENDABLE MASTER MULTITESTER ON 10 DAYS' FREE TRIAL



ONE METER DOES THE WORK OF 41 \$31.50

A portable testing instrument superior in range, accuracy and convenience—a whole service shop in one Dependable instrument.

- ★ Measures resistance from 1/2 ohm to 40 million ohms in 6 ranges. Measures capacity from .0001 to 300 mfd. in 5 ranges.
- ★ Measures AC & DC milliamperes from 10 microamperes to 2 1/2 amperes in 6 ranges—no other combination instrument made will measure AC milliamperes—with television just around the corner an instrument testing AC milliamperes will soon become a necessity for every radio service shop.
- ★ Measures AC & DC voltages from 1/10 volt to 1000 volts in 5 ranges. Measures inductance in 5 ranges and decibels in 4 ranges.

Weight 9 pounds, size 11 1/2 inches x 10 1/4 inches x 5 1/4 inches. The **DEPENDABLE MASTER MULTITESTER** is convenient to carry and simple to operate.

GRENPARK COMPANY
99 HUDSON STREET, NEW YORK, N. Y.

GRENPARK COMPANY RC-11
99 Hudson Street, New York, N. Y.
Gentlemen: Please send me
 A Dependable Master Multitester, \$31.50 Enclosed.

Name

Address

City State

It is understood that if I am not satisfied with my Dependable Master Multitester, I can get my money back within 10 days of purchase.

Please Say That You Saw It in RADIO-CRAFT

THE NEW PHILCO SYSTEM OF TELEVISION

(Continued from page 270)

tained, first by wire. The next step was to reproduce this at a distance by radio. Experimental television transmitter W3XE, was rebuilt, and with power increased to 1.5 kw. images again were flashed over the roof-tops of North Philadelphia. This was the beginning of the fourth stage in the development.

The job of transmitting over the city of Philadelphia and its suburbs television signals of sufficient strength to give usable high-definition pictures at a distance of at least 7 miles from the plant, was not an easy one on the ultra-high frequencies used for television. The newest ideas in ultra-high frequency transmitters, antennas and transmission lines were tested. Considerably more power was required at the transmitter to cover the desired distance than sound-broadcast experience would indicate.

A NEW METHOD OF MODULATION

One of the most difficult problems to be solved was the modulation of the transmitter by the very high video frequencies (generated by scanning) necessary for high-definition television pictures. It is a relatively easy matter in a sound transmitter to modulate from 30 to 10,000 cycles, but when the upper limit of the modulation band is pushed to 2.4 megacycles (2,400,000 cycles), the problem of constructing amplifiers and modulators appears at first insurmountable. The solution was the invention of a new and unique type of modulation.

EXPERIMENTAL RADIO RECEIVERS

Concurrently, ultra-high frequency radio receivers (42-86 mc.) were being developed to faithfully reproduce these high modulating frequencies necessary for clear, high-definition pictures. Receivers for the accompanying sound were also developed so that the apparatus necessary to receive a television program (sound and image) could be placed in an ordinary console.

With all of the units of a complete system developed and operating satisfactorily, field tests were ushered in on Dec. 23, 1935 by a 1-hour program reproduced at a distance of 7 miles from the transmitter. It showed the system lacked many desirable features. Nevertheless, the results were sufficiently promising to warrant pushing development work with greater speed. The engineers once again concentrated on the weaker links of the system, to remove the causes of weakness and to improve the image. Subsequent demonstrations made at frequent intervals (to executives and their guests) showed rather slow but steady progress up to that point where scheduled programs were broadcast nightly covering Philadelphia on 51 mcs. (image) and 53.25 mcs. (sound). These were started June 18, 1936.

THE PHILCO SYSTEM

You may be surprised to find that our television system does not bear an individual's name. This is the way it should be. It is the combined work of a group of television experts, each of whom has contributed to its completeness and effectiveness. One of the reasons for the development of a successful system in a relatively short period of time has been the "team spirit" which exists.

The electrical specifications for this system are given briefly in Table I.

TABLE I	
Channel width	6 mcs.
Spacing between television and sound carriers	3.25 mcs. approx.
Polarity of transmission	Negative
Number of lines	345
Number of images per second	60 interlaced
Aspect ratio	4:3
Percentage of television signal devoted to synchronizing	20 per cent
Synchronizing signal	Narrow vertical
Carrier frequency of image transmitter	51 mcs.
Carrier frequency-sound transmitter	53.25 mcs.

These specifications agree with the standards recommended by the RMA at a recent hearing before the F.C.C., that is, except for the number of lines. As soon as the equipment can be changed, it will conform with the new suggested standard of 440-450 lines. This matter of having one television standard for the U.S.A. is very important. It will be appreciated by every future television user.



A typical studio setup showing the "camera."

SEQUENCE OF SET-UP

The description which follows will give a general idea of just how the system works. The logical starting point is the studio, where the television signal is generated. The studio is located in our main laboratories, at C and Tioga Streets. A special tube camera generates by electrical scanning, voltages corresponding to the light and shade of the television image which is focused by a lens on the signal plate of the tube. This signal is amplified in cascaded stages (about 10,000 times) in the control room until it has sufficient amplitude to modulate the ultra-high frequency transmitter. Mixed with this television signal, in the proper proportions, are synchronizing and blanking impulses. These control at the various television receivers in the field, the movement of the electron beam in the picture tubes and place around 2 sides of the image a black border. To pick up the sound accompanying the image, the studio is equipped with microphones and associated equipment, which permit transmission of high-fidelity sound from the ultra-high frequency sound transmitter operating on a frequency spaced 3.25 mcs. above the television carrier wave. Further description is unnecessary since there is nothing unusual about the sound channel.

Motion picture film, when passed through a specially-built projector, is transmitted by flashing "pictures" intermittently into the so-called "electric eye," or camera tube. This projector is designed so that the film and its sound track is moved at a speed of 24 frames per second, for satisfactory sound, and at the same time 30 frames per second are transmitted to secure 60 interlaced "pictures" per second.

For outdoor television scenes the camera is placed on a motion picture tripod and motion picture technique is used in its operation.

The latest experimental model of cabinet comprises a sound and television receiver tuning over the frequency range of 42-86 mcs. For flexibility these receivers are separately tuned, although it is easy to secure single-knob control. The number of control knobs, you will notice, is only slightly more than on the usual sound receivers. These are not difficult to operate. Our field tests have shown that inexperienced persons can adjust the knobs to secure satisfactory pictures. The *deflecting chassis* is the name given the unit which incorporates the synchronizing and deflecting equipment. The power-supply units are placed at the bottom of the cabinet. The total number of tubes used at present is 36.

No attempt will be made to describe the receivers in use today in detail, because they are merely current experimental models—changed as improvements are made.

The large majority of readers will have two television questions they would like to have answered—"When?", and "How Much?" Mr. L. E. Gubb, President, Philco Radio and Television Corporation, answered the former question at the first of this year in the *New York Times* by saying "commercial television will not come during 1936." This was a definite statement. Just when commercial television will arrive no one can say. It may be in 1 year or it may be in 5. A great deal of work must be done in transmitter and receiver development and a great deal of money must be spent to assure transmitting facilities and programs for the prospective television audience. There are many other problems as well.

It is too soon to answer the question of "How much?" Estimates or rather guesses have been made that television receivers will cost, upon introduction, \$500.

TUNG-SOL DEALERS

make money

WITHOUT INVESTING A CENT



The Tung-Sol plan was the first and is today the only nation-wide consignment plan for selling radio tubes. It has been successful because Tung-Sol dealers carry adequate stocks of tubes which build customer satisfaction, and make full profits on their sales.

There are still desirable locations where independent service organizations who can meet requirements may be appointed as agents. Ask your nearest Tung-Sol wholesaler.

TUNG-SOL

Tone-flow radio Tubes.

TUNG-SOL LAMP WORKS, INC.

Radio Tube Division
NEWARK, N. J.

Meissner

REMOTE CONTROL Adaptor Unit

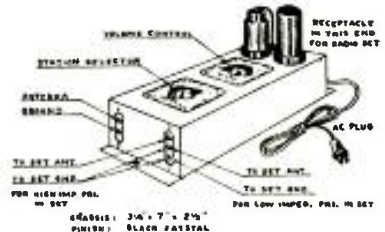

At last! A remote control unit that operates efficiently. No complicated motors, relays, etc., which made the old time remote controls impractical. The only connections necessary are a single duplex wire from the unit to the receiver and the insertion of the AC plug into a wall receptacle. Unit is completely self powered and needs no batteries or leads to the power supply of the receiver. Operates independently of the radio controls on the receiver. Ideal for homes and a positive necessity for invalids, taverns, restaurants, etc. The arm chair lover's companion. The possibilities of this unit are unlimited. Etched and polished control escutcheons. Bakelite bar type control knobs. Black crystal finished metal chassis. Entire assembly is attractively finished. Completely assembled and ready to wire. Detailed diagrams and instructions supplied. Uses 1 type 25Z6, and 1 type 6A8 all metal tubes.

Model No. 7520—Remote control unit for broadcast reception .. **\$11.50**

SOLD BY ALL LEADING JOBBERS

MEISSNER MFG. CO.
Mt. Carmel Illinois

ATLAS SOUND BAFFLES

The most complete line of baffles yet to be offered! Types, and models, for all size speakers, from 6 to 14 inches. Many new and improved models of aluminum deflector baffles.



Atlas new Fall Catalog presents the most complete P. A. line for the coming presidential campaign. Amplifiers—Mike Stands—Unbreakable Aluminum Exponential Trumpets—etc.—Write today.

ATLAS SOUND CORPORATION

1454 39th Street Brooklyn, N. Y.

WHAT TO MAKE and how to make it ON A LATHE

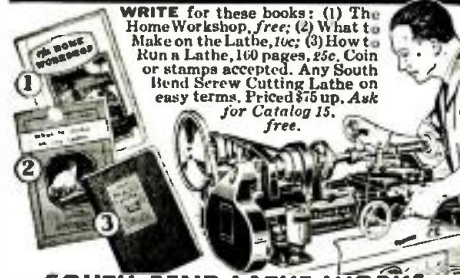

WRITE for these books: (1) The Home Workshop, free; (2) What to Make on the Lathe, 10c; (3) How to Run a Lathe, 160 pages, 25c. Coin or stamps accepted. Any South Bend Screw Cutting Lathe on easy terms. Priced \$75 up. Ask for Catalog 15. Free.

SOUTH BEND LATHE WORKS

533 Madison St., South Bend, Indiana, U.S.A.

ICA "DE LUXE" NEUTRALIZING and ALIGNING TOOL KIT



Complete for Service Needs

The ICA "Deluxe" Neutralizing and Aligning Kit is the answer to a Serviceman's prayer. It is compact, can be carried in the pocket or attached to the belt. It contains all of the "called for" Radio tools, including the ICA Magic Tuning Alignment Tool and the recently developed ICA flexible screwdriver. Cat. No. 994. Complete with rugged carrying case and fourteen tools. List **\$4.50**

INSULINE CORPORATION OF AMERICA
27 PARK PLACE NEW YORK

6 VOLT D. C. and 110 VOLT A. C. AMPLIFIERS

SPECIAL OFFER: 60 Watt 6L6 110 volts A.C. model 500-15-8-4-2 Ohms Output, 3 Channel Input Mixer, Hi-&Lo Equalizer, complete with \$40 Ribbon or \$37.50 Crystal Mike, two Rola G-12 A.C. Speakers. Crystal Pick-up. Special offer for the entire system **\$95.00**

COLUMBIA SOUND CO., Inc.
135-R Liberty Street New York

SAVE \$\$\$ on RADIOS

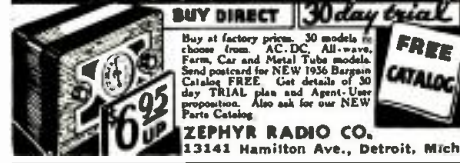

BUY DIRECT 30 day trial
Buy at factory prices. 30 models to choose from. AC, DC, All-wave, Farm, Car and Metal Tube models. Send postcard for NEW 1936 Bargain Catalog FREE. Get details of 30 day TRIAL plan and Agent-User proposition. Also ask for our NEW Parts Catalog.
ZEPHYR RADIO CO.
13141 Hamilton Ave., Detroit, Mich.

Correspondence Courses in RADIO and ELECTRICAL ENGINEERING

ELECTRICAL ENGINEERING covers complete electrical field. Most modern course. So simplified anyone can grasp it quickly. **LOW COST!** Only \$25. Deferred payment plan. **RADIO ENGINEERING** Ultra-modern course in radio public address photo-electric work. Trains you to be super-service man, real vacuum tube technician. Diploma given. Tuition only \$25. Deferred payment plan.
FREE Write today for free copies of school catalogs, student magazines, etc. Get started at once. **SEND NOW!**
LINCOLN ENGINEERING SCHOOL, 859-N So. 37th St., Lincoln, Neb.

ELECTRONIC MUSIC FUNDAMENTALS

(Continued from page 291)

all of the instruments have always lacked somewhat in design and practicability, which handicapped their appearance before the musical public.

9. A very important handicap in the production of successful electronic musical instruments has been that of *tuning*. Without dependable tuning, the instrument is worthless. Everyone knows that the piano can stay in tune for many years, while an electronic musical instrument may get out of adjustment in a short time, and thus be subject to severe criticism by practical and prejudiced musicians. The solution for correctly tuning the instrument and keeping it in tune, or keeping a number of instruments in tune so that they can be played together, as legal records show has been invented by Eremeeff (1923), and patented in 1933—patents Nos. 1,924,713 and 2,033,232.

10. Electrical musical instruments, with volume-changing tremolo, are being built by many experimenters, who use different methods for actuating the volume control of the instrument, or periodically varying the output of the electrically-produced tone. Tremolo produced by these methods is colorless and monotonous and opposite the pipe organ practice, where wind pressure is varied, thus producing a change of pitch as each pipe is sounded. Variable-pitch tremolo which changes, slightly and periodically, the frequencies of musical tones, produced electrically, on the flat and sharp side (just as the violinist produces vibrato on the violin string with his fingers), is shown in patents Nos. 1,990,024 and 2,033,232.

11. A single-tone generating unit, electromagnetic or photoelectric, supplying current to the manuals and pedal clavier, can be found in patents Nos. 1,924,713 and 2,033,232.

12. The use of features such as key-clicking arrangements, consisting of resistance and capacity, are used extensively in radio and telephone practice. Transformers with taps on the primary or secondary, are shown as adapted for musical purposes, in patent No. 1,749,685. In order to drive the phonic wheels at constant, uniform speed, resilient springs are used, as shown in *Television News* magazine, September, 1931, page 274. Various arrangements of the gear drive have been suggested in earlier patents of Cahill, and the Thomas patent, No. 1,156,329. The generation of high frequencies by electro-mechanical devices introduces additional parasitic frequencies which must be removed by an electrical filter, as shown in patent No. 1,924,713. The console design, key arrangements, and swell pedal can be found in the patent of Henroteau, No. 1,850,267. Mixing circuits and pre-set combinations have been suggested by Johnson, in patent No. 1,721,865 and in No. 1,924,713 of Eremeeff. Mechanical filters are known in sound motion picture practice for making constant the movement of the film; flywheels, flexible joints, and spring couplings are also well-known and may be used by experimenters, although most of the features described in these 12 paragraphs are in a special "NRA" patent, No. 1,956,350.

In order to construct an electronic organ, standard dimensions, established by organists, must be maintained. For example, the height from the pedals to the manuals, the distance between manuals, the overhanging of the manuals in regard to the console, must be correct. The swell pedals or volume pedals must be placed correctly in regard to the pedal clavier or manuals. The pedal clavier must be radiating and concave, with 32 pedals, beginning with the 32-cycle note. The manuals must have 61 keys, beginning from C=65 cycles, and the keys must be over-hanging. The bench design must conform to the height and distance from the console. The stop tablets must be of conventional design and conveniently placed before the musician. It is also desirable to have one or more speakers for an echo-organ effect and a plug for phonograph attachments, and microphone, when the organ amplifier and reproducers are used for a P.A. system. See patent No. 2,033,232.

For information regarding sizes and standard dimensions for the construction of organ consoles, pedal claviers, and other necessary information developed by musicians, readers are advised to write to the Guild of American Organists, care of *Radio-Craft*. (Be sure to enclose a stamped envelope.)



Learn More About RADIO and A B C of AIR CONDITIONING

THE RADIO-CRAFT LIBRARY SERIES—a most complete and authentic set of Volumes—treats individually, important divisions of radio. Each book has been designed to give you the opportunity to learn one or more branches of radio. The authors of the books are well-known to everyone. Each is an expert radio man; an authority on the subject—each is thoroughly familiar with the field which he represents.

All Books Uniform

The volumes in the RADIO-CRAFT LIBRARY SERIES are all uniform, 6 x 9 inches. Each book contains on an average of 50 to 120 illustrations. The books are printed on an excellent grade of paper which makes the type easy reading.

- No. 1
RADIO SET ANALYZERS
By L. VAN DER MEL
- No. 2
MODERN VACUUM TUBES
By ROBERT HERTZBERG
- No. 3
THE SUPERHETERODYNE BOOK
C. J. FITCH
- No. 4
MODERN RADIO HOOK-UPS
By R. D. WASHBURNE
- No. 5
HOW TO BECOME A RADIO SERVICE MAN
By LOUIS MARTIN
- No. 6
BRINGING ELECTRIC SETS UP TO DATE
By CLIFFORD E. DENTON
- No. 7
RADIO KINKS AND WRINKLES
By C. W. PALMER
- No. 8
RADIO QUESTIONS AND ANSWERS
By R. D. WASHBURNE
- No. 9
AUTOMOBILE RADIO AND SERVICING
By LOUIS MARTIN
- No. 10
HOME RECORDING AND ALL ABOUT IT
By GEORGE J. SALIBA
- No. 11
POINT-TO-POINT RESISTANCE MEASUREMENTS
By CLIFFORD E. DENTON
- No. 12
PUBLIC ADDRESS INSTALLATION AND SERVICE
By J. T. BERNSELY
- No. 13
A B C of AIR CONDITIONING
By PAUL D. HARRIGAN
- No. 14
POCKET RADIO GUIDE
By NAT LESSEM

BIG DISCOUNT OFFERED When Five (5) Books or More Are Ordered, Deduct 20%

GERNSBACK PUBLICATIONS, INC.
99 Hudson Street, New York, N. Y.

GERNSBACK PUBLICATIONS, INC. RC-1136
99 Hudson Street, New York, N. Y.
I have circled below the number of books in the RADIO-CRAFT LIBRARY SERIES which you are to send me, and have deducted 20% for ordering five (5) books or more. I have included my remittance in full, at the price of 50c each, when less than five books are ordered.

The amount of my remittance is..... (stamps, checks or money orders accepted). Circle numbers wanted:

1 2 3 4 5 6 7 8 9 10 11 12 13 14

Name

Address

City State

All books are sent postage prepaid

Please Say That You Saw It in RADIO-CRAFT

PUTTING NEW TRICKS IN OLD SETS

(Continued from page 290)

tube with the identical characteristics of a 78, but having 7 prongs, while the 78 has 6. The 7th prong is a ground for the metallic zinc coating on the tube which acts as a shield. The same is true of the G-6ATS, the next tube in the line-up, only the shield in this case is internally grounded to the cathode of the tube. The third tube is a G-6ETS, used in the I.F. stage. Next comes a total stranger and only used in this and the Ford-Majestic which was used in the glove box on the 1934 Fords. It is a G-6CTS and is a double-diode triode with low mu constants. It is similar to the 85, but with a gain of 20, which places it slightly above that tube but under the 75 or 6B7. It has 7 prongs which utilize one as a grounding prong for the spray shield, like the G-6ETS. The output stage is a conventional 89 connected as a pentode, having an output consistent with what was considered good, back in the days when this set was first introduced—also they did not have the 42 at that time. The rectifier is a full-wave mercury-vapor type, with the spray-shield connected to its separate prong on the tube socket base.

Well, so much for that. The circuit is fairly conventional, gain consistent with what was considered necessary in the time, and likewise the output. But how you can make that set "sit up" by making a few changes—and at a total cost so low that it will surprise you.

Suppose we get one in for service. The set is weak, doesn't play or some other reason. Take a good look at the set, especially the vibrator, which is shown in partial detail in Fig. A. If, during the inspection of this unit, it is found that the points are blackened and pitted, sell the customer either a new vibrator replacement unit, several of which are on the market; or else a new power unit, replacing both the vibrator, transformer and rectifier. This is the safest in the long run as the 6Y5 tube is a bad, bad actor and cannot be relied upon. In any event, even if you have to sell an inexpensive replacement vibrator head, figure-in on replacing the 6Y5 with one of the (Sylvania) replacement types, which is an 84 with a shield and an additional prong for the ground. Well, considering that this item has been straightened out to both yours and the customers' satisfaction, do a "build-up" on the set itself, and tell the customer that you will guarantee to rebuild this set into one that will be the equal if not the superior of any set using 6 or 7 tubes being sold today. Don't be afraid of losing the bet, because I have found from experience that every owner of a Majestic is thoroughly sold on that set, and selling him an improvement will tickle him.

Now let us take a look at the re-vamped circuit, Fig. 2, and see what has to be done to this set to make it better. First note that we have removed the 6C7 and replaced it with a 6B7 in a circuit having a tremendously higher gain. We have replaced the output with a 42 tube, having an output of 3.5 W., and we have utilized the latest type of circuit in doing it. Note especially the fact that nothing was done to the R.F. or I.F., outside of lowering the value of R4 (the cathode resistor on the R.F.-I.F.) from 400 ohms to 200 ohms. This was done because in re-vamping we removed the circuit delay on the A.V.C. to give better action, and in accordance with that a slightly higher threshold value is desirable—although not necessary.

GETTING DOWN TO CASES

Well, let's get to work. First remove, disconnect and abolish the local-distance switch on the upper-left-hand corner. It consists of a switch to ground out the 10,000-ohm section of the cathode resistor in the 6C7. As we are using a diode-biased amplifier in the new circuit, no bias is necessary on the 6B7. Start at the output, and work forward. Turn the set over on its back, with the tone control in the upper-left-hand corner and proceed to utilize those sharpened cutters. First, cut out that nice 0.1-mf. condenser, C24, and stow it in the "booty-box." Few people use a separate speaker with this job and the few that do always complain because of the difference in tone and are dissatisfied.

Next remove the 10 mf. tubular electrolytic, C12, bypassing the cathode of the 6C7. This also is of no further use in the new circuit. Next, unground the two condensers (micas) on the plate filter circuit of the 6C7 (C20, C21, on origi-

nal diagram) and loosen up the choke, being careful not to break the wires. Fold this back out of the way. Now the grid of the 89 tube is on the top of the tube and the grid of the 42 tube is on the base, so commence to re-wire the socket to take a 42. As the plate and filament wires are identical, all that will be necessary will be to unground the cathode from the ground that runs over to the preceding tube screen-grid and ground, and ground it conveniently at the base of the socket itself. Then run the grid wire (green) over to the remaining terminal.

Incidentally, the question of bias might be raised at this point. Note that the output tube receives its control-grid bias from the drop in the choke in the power supply. When using the 42, this raises the bias on the 42 to approximately 20.5 V., but as we are really going to "drive" this tube from now on, due to the high amplification in the 6B7, a slightly higher bias is a help instead of a hindrance.

Now look at the original diagram, and compare it with the newer layout. It will be noted that we dispose of the following resistors and condensers: R8, R9, C10, C12, C13, C14. The resistors R8 and R9 are located on the lower-left-hand side of the resistance terminal board and connect with the cathode of the socket and ground. Clip them off and ground the cathode at any convenient point on the chassis. Condensers C10, C13 and C14 are located within the blocked section located on the side of the power unit case and their leads can be conveniently traced, located, clipped and taped. Note that C10 is a complete unit in itself having two leads (brown)—it does not ground, but runs from the junction of R5 and R6, back to the case and out through to the top of the volume control. As we are going to use the same volume control, do not clip the lead off at the control, but rather close to the block, then change over resistor R6 so that it occupies the position shown in the new circuit and run the brown wire from the low end of this resistor (0.1-meg.) back to the volume control. We do not touch the control-grid, as it runs directly from the arm to the grid, and the tube gets its bias from the diode circuit in the A.V.C. action of the set. (The circuit really should have an 0.25-meg. volume control in this circuit, but the writer has used the 0.2-meg. control without any indication of excessively high voltage on the control-grid at any setting.)

Now we come to the screen-grid of the tube. Insert a 1.5 meg. resistor between the screen-grid and "B" plus, taking this from the resistor board at the top-left-hand side, where the screen-grid of the 42 comes down through the speaker opening from the output transformer, and also install a fairly husky 0.25-mf. condenser at the screen-grid of the tube to bypass it. Also, replace R11 (an 0.25-meg. resistor) with a 0.5-meg. unit. Be sure when doing this and the following operation, that you get on the right side of the resistors. In the ease of the change-over of the volume control note that it is in series with the 0.1-meg. resistor which, in turn, goes over to the yellow lead to the 2nd I.F. combination (consisting of the chokes, coils and two condensers—which by the way are all within the can as sketched on the new diagram).

In order to make doubly sure about this combination, note the following. The blue lead (rubber covered) which runs over to the extreme right-hand terminal of the caudom resistor on the front of the set is not the proper terminal of the 0.3-meg. resistor to terminate R6, but the other end of it which is the extreme right-hand side of this resistor (on most of the sets). However, the diagram sets this out clearly, and an ohmmeter will show the radio man which terminal is right. Incidentally, the value of the resistor that connects from the grid terminal of what is now to be the 6B7 tube, to the junction of R5 and R6, due to the choke in the circuit is fairly high.

Next, replace R4, the cathode resistor of the I.F. and R.F. tubes. This resistor is located under condenser C30, which is located directly over the I.F. tube socket and connects from the fuse block to ground. The easiest way of doing this is to unsolder the lead from the fuse block, lay the condenser back and replace the resistor; then resolder the condenser securely and make sure that both the fuses are OK, and that the terminals are not corroded or have a bad contact, since, if they do, either the tubes will not light,

(Continued on page 319)

Please Say That You Saw It in RADIO-CRAFT

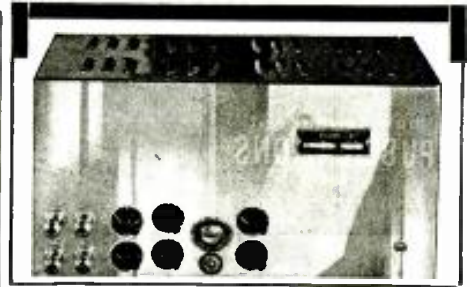

THE SENSATIONAL "30-60" 28 SOUND SYSTEMS IN ONE!

THE MASTERPIECE "30-60" is the only truly universal sound system being built today. It will cover an outdoor audience of 50,000 people—or 1,500 pairs of headphones in a hospital. It is the most flexible sound system ever designed in terms of inputs, outputs and power output of anything from one watt up to sixty-four honest man-sized watts at 2½ times less than customary total harmonic distortion. It has a dozen entirely new technical features—and such mechanical advantages as rack mounting, wall mounting and portable operation all in one unit.

Any MASTERPIECE amplifier may be purchased on Easy Terms with a 5-Year Guarantee and a Free Trial under your own conditions. Send the coupon for full details.

McMURDO SILVER MASTERPIECE AMPLIFIERS

FULL DETAILS FREE

MAIL THIS COUPON!

McMURDO SILVER CORP.
3356 N. Paulina St.,
Chicago, Ill. U. S. A.

Please RUSH me full details on MASTERPIECE amplifiers.

Name

Address

Build Your Own Wheatstone Bridge For \$45.00

A simple, rugged, wide-range Wheatstone Bridge for resistance measurements. Operation identical with best laboratory instruments. Sensitive, accurate. Low cost. Kit easily assembled.



SHALLCROSS No. 630 Kit \$45.00
Assembled \$50.00

Built around a highly sensitive galvanometer and Shallcross Resistors. Range .01 ohm to 11.1 megohms. Send 6c in stamps for Bulletin 631-PG.

SHALLCROSS MFG. COMPANY

Electrical Measuring Instruments
and Accurate Resistors

700 MAC DADE BOULEVARD
COLLINGDALE, PA.



WE list below a large number of radio, short-wave, and mechanical "how-to-make-it" designs. Each is a special publication originated by masters in their respective fields. For the first time, at the low price of TEN CENTS, you are now enabled to buy a complete design with photographic reproductions, complete mechanical layout, and full description to make it possible for anyone to build the project in question.

The name of "Radio Publications" has become a household word because this company has for many years specialized in radio and other literature of special interest to the experimenter.

PLEASE ORDER EACH PROJECT BY ITS PUBLICATION NUMBER, and use the special coupon below.

We accept money-orders, cash, checks or new U. S. stamps. (No foreign stamps or currency can be accepted.) If you send cash or stamps, be sure to register your letter to safeguard against loss.

Money refunded if you are not satisfied.

ANY TWELVE PUBLICATIONS FOR ONE DOLLAR

Partial List of New 10 Cent Publications

SHORT-WAVE RECEIVER PUBLICATIONS

- HOW TO MAKE THE 2 TO 5 METER TWO-TUBE LOUD-SPEAKER SET.** This receiver may be used with batteries or with an A.C. power pack. Packs a big wallop. . . . No. 107
- HOW TO BUILD THE CIGAR-BOX 1-TUBE "CATCH ALL" RECEIVER.** A short-wave battery set which fits into a small cigar-box, insuring high portability yet great efficiency. . . . No. 111
- HOW TO BUILD THE PORTABLE MINIDYNE SHORT-WAVE BATTERY SET.** Uses no aerial, no ground. The total weight is 3 1/2 lbs. and measures 5x5x6 inches. Self-contained batteries, tube, condensers, and loop. Highly sensitive circuit. . . . No. 114
- HOW TO BUILD THE HAN-BAND "PEE-WEE" 2-TUBE.** A dandy receiver with high efficiency and handisread tuning. Works a loudspeaker, yet the entire receiver is no larger than your hand. Works with either batteries or an A.C. power pack. . . . No. 115
- HOW TO BUILD THE DUO-AMPLIDYNE.** The Ideal 1-tube set for the beginner. One of the finest 1-tube sets; it really gives 2-tube performance. Made for battery operation. With only ten-foot antenna brings in the good European stations. . . . No. 116

RADIO BROADCAST RECEIVER AND SPECIAL RADIO PUBLICATIONS

- HOW TO BUILD A SUPER-SENSITIVE ALL-WAVE CRYSTAL SET.** Just the thing for beginners who wish to have an easy-to-operate crystal set on all-waves and which will separate all the stations. Can be made for less than \$2.00. Uses no tubes or batteries. . . . No. 121
- HOW TO BUILD THE 2-TUBE "PENTODE PORTABLE" BROADCAST SET.** The lightest, smallest set giving loud-speaker volume on batteries. Weighs less than 1 1/2 pounds. Built in a small, portable case. . . . No. 122
- HOW TO BUILD THE RADIO "TREASURE" FINDER.** This is a really sensitive and practical "Treasure" finder. Simple to build and guaranteed to work. Uses 4 tubes. Can be built for less than \$15.00. . . . No. 123
- HOW TO BUILD THE GERNSBACK ONE-TUBE PENTODE LOUD-SPEAKER SET.** This is the best one-tube loud-speaker set ever constructed. It works on batteries, and is for broadcast reception. Extremely sensitive. . . . No. 124
- HOW TO BUILD THE WORLD'S SMALLEST ONE TUBE BATTERY RADIO.** So small that it is actually built in a cigarette case. The wonder set of the last New York radio show. . . . No. 125

MECHANICAL PROJECTS PUBLICATIONS

- HOW TO BUILD A PEE-WEE AUTOMOBILE.** An ultra-small automobile for less than \$10 dollars. Will carry two 17-year-old boys. Runs 35 miles per hour and 100 to 125 miles on one gallon of gas. . . . No. 132
- HOW TO MAKE A BAND SAW FROM OLD AUTO PARTS.** Made from old Ford and Chevrolet parts. Capable of performing delicate and satisfactory work. Uses 25-minute 10 and 12-inch hand saws. Assembly is easy for each part fits in one place. . . . No. 135
- HOW TO BUILD A REAL LATHE FOR \$5.00.** Requires a few hand tools, about \$5.00 worth of raw material and patience to build. The lathe is capable of drilling, milling, trimming, boring and threading. . . . No. 136
- HOW TO BUILD A SIMPLE PORTABLE REFRIGERATOR.** A real refrigerator. Does not use ice. The cooling unit operates from an alcohol flame, oil burner or open fire. Easy and inexpensive to build. Excellent for boats, camps, picnics, etc. . . . No. 138
- HOW TO BUILD LARGE TESLA AND QUIN COILS GIVING 18-INCH SPARKS.** Interesting high-frequency apparatus with which many high-frequency and x-ray experiments can be performed. Capable of producing 15,000 volts. . . . No. 141
- HOW TO MAKE AN ARC WELDER.** A real arc welder capable of doing commercial jobs satisfactorily. Uses a heavy duty transformer which costs from the 110-volt A.C. main. The output of the machine ranges from 15 to 100 amperes. . . . No. 142
- HOW TO USE AN A.C. ARC WELDER.** Companion publication to the one listed directly before. Very informative especially to the faraway man or mechanic who has had little or no experience with an arc welder. Contains many important diagrams and photostrips of actual work done with an arc welder. . . . No. 143
- HOW TO MAKE YOUR OWN MICROSCOPE.** A microscope which the home mechanic can easily build in his shop. The lenses are obtained from the finder of a camera. Although simple and easy to build, it is a thoroughly practical and efficient instrument. . . . No. 144
- HOW TO MAKE A WIMSHURST ELECTROSTATIC MACHINE.** An easily constructed generator of static electricity capable of discharging a fat three-inch spark. Used in schools where electricity is taught. Can be built for less than \$2.00. . . . No. 145
- HOW TO MAKE A POWER DRILL PRESS FROM SCRAP PARTS.** An excellent practical drill press that will make work easier for the mechanic. About \$2.00 worth of raw material and scrap iron are the only requirements. . . . No. 146
- HOW TO MAKE AND EXPERIMENT WITH AN ELECTROPHORUS.** With this device numerous interesting experiments with static electricity can be performed. Many of these experiments are thoroughly explained and illustrated. . . . No. 148

RADIO PUBLICATIONS 99A HUDSON STREET NEW YORK, N. Y.

RADIO PUBLICATIONS, 99A Hudson Street, New York, N. Y. RC-1136

I enclose \$..... for the publications listed by number, at right, at 10c a copy (ONE DOLLAR FOR ANY TWELVE PUBLICATIONS.) These publications are to be sent to me postpaid. I have placed a circle around each number which I want.

Send me also your list of 27 other 10c publications.

Name Address

City State

107	111	114	115	116
121	122	123	124	125
126	127	128	129	132
135	136	138	141	142
143	144	145	146	148

CLASSIFIED ADVERTISEMENTS

Advertisements in this section are inserted at the cost of fifteen cents per word for each insertion—name, initials and address each count as one word. Cash should accompany all classified advertisements unless placed by a recognized advertising agency. No less than ten words are accepted. Advertising for the December, 1936, issue should be received not later than October 31st, 1936.

A.C. AUTO GENERATORS

TURN SCRAP INTO MONEY. AUTOPOWER SHOWS you how easily and economically auto generators can be converted into A. C. or D. C. generators and D. C. motors. 2 to 1000 volts; for sound, radio, power, light, or welding. No previous experience necessary. Complete information all in new book, with simple instructions and illustrations. Endorsed by thousands. Only \$1.00 postpaid. Autopower, Inc., 408-V S. Hoyne Ave., Chicago.

HELP WANTED

EXPERIENCED RADIO TESTERS AND WIREMEN wanted. Positions immediately available. Apply Radio Office, 5 E. 19th St., N. Y. C.

RADIO

RADIO ENGINEERING, BROADCASTING, AVIATION and police radio, servicing. Marine and Morse Telegraphy taught thoroughly. All expenses low. Catalog free. Dodge's Institute, Pine Street, Valparaiso, Indiana.

FARM AND CITY RADIOS, \$6.95 UP; SAVE OVER 60 per cent; amazingly new farm radio; operates from free windpower; new farm booster or battery. Lowest cost electric lights. Agency-clean up; catalog; free offer. Marco Company, 264 E. 14th, Kansas City, Mo.

MAKING A Q-TEST ADAPTER

(Continued from page 285)

List of Parts.) The unusually fine construction of this condenser permits its losses to be neglected since its effective resistance (at resonance) is negligible.

The resistor across which the oscillator voltage is applied is of interest to the constructor. The material from which this resistor is made should be carefully chosen to have an extremely low temperature coefficient. As the resistance value is so small—0.05-ohm—the resistor cannot be obtained except on special order, so it is made by the constructor. "Advance" or "Coupron" wire, No. 22 B. and S. gauge, is used. A 1 1/2-in. length supplies the desired resistance value. This length of wire is soldered directly to the terminals provided for the oscillator connections.

CONSTRUCTION

So much for the design factors. The actual construction of the Adapter is not at all difficult. The circuit of the complete instrument is shown in Fig. 1, and a complete list of parts appears at the end of this article.

A small box chassis is used, in conjunction with the front of the metal case. The parts are mounted in the positions shown in Figs. A, B and C. This layout keeps leads as short as conveniently possible, yet it keeps the power circuits entirely removed from the voltmeter and Q circuits.

It is quite important, in this unit to use the specified parts, since the indicating instrument is unusually delicate (0-500 microamperes) and any change in the values of the parts is likely to cause the needle to swing off scale—as well as changing the calibration of the V-T. voltmeter.

In wiring the unit, care should be taken to keep wires well separated; and heavy, well-insulated wire should be used, throughout. This is especially true of the grid wiring of the 954 tube, and all wiring to the terminals, which are of the porcelain "stand-off" type.

When the wiring has been completed, according to Fig. 1, it should be very carefully checked, before the power is turned on. The tubes may then be inserted in their sockets and the power plug inserted in the power line.

A note here may cause trouble later:—Since the power supply is directly connected to the line, without any intervening transformer, the chassis of the Q Tester should never be grounded directly, but only through the 0.1-mf. condenser provided in the ground lead. (The condenser ground should always be provided during tests.) Also, when testing coils, condensers, etc., in a set, the set should be disconnected from the line—or care must be used to plug the Q Tester correctly into the line, so that the chassis of the Tester is connected to the grounded side of the line. Failure to observe these instructions may result in fire-works!

ADJUSTING THE VOLTMETER

The V-T. voltmeter may be calibrated by turning the switch Sw. 2 to the V.T. V.M. position, turning on the line switch, adjusting the Zero Adj. knob until the needle is a zero, and connecting the terminals C and D to the secondary of a filament transformer with a high-resistance wire-wound variable resistor in series with the winding. Then, by means of an A.C. voltmeter of the usual moving-vane or hot-wire type, a calibration curve for the V-T. voltmeter can be run, from zero volts to the maximum (which is about 5 V. with the specified cathode resistor and plate voltage).

In using the Q Tester as a comparative instrument for judging the merit of coils, the following procedure can be followed. The actual calibration of the instrument will be given in Part III, but it can be used for comparison purposes without this calibration.

First, adjust the meter for Zero, with Sw.2 in the Q Adj. position, as explained above. Then, insert a coil in place of the Jumper, turn the condenser, C1, to the position corresponding to the capacity of the tuning condenser to be used for the coil, and turn the service oscillator to resonance with the coil and standard condenser. The position of resonance will be indicated by the maximum deflection of the Q meter. (The position of the needle in Q Adj. position, with the oscillator turned on should be noted and the output control on the oscillator should be used to maintain the setting for all tests. The meter reading can then be recorded and the procedure

ADVERTISERS' INDEX

Aerovox Corporation.....	306
Allied Engineering Institute.....	311
Allied Radio Corp.....	297
Amplifier Co. of America.....	Insert
Amplitone Products Co.....	210
Arrow Sales Corporation.....	304
Atlas Sound Corporation.....	316
Autoerat Radio Company.....	306
Birnbach Radio Company.....	311
Blau, the Radio Man, Inc.....	312
Bunstein-Appelbee Company.....	301
Central Radio Laboratories.....	300
Chanaudagraph Corporation.....	310
Classified Section.....	318
Cough-Bregale Company.....	295
Columbia Sound Co., Inc.....	316
Continental Carbon, Inc.....	304
Cornell-Dublier Corp.....	Insert
Coyne Electrical School.....	257
Dodge's Institute.....	306
Dreml Mfg. Company.....	312
Ellen Radio Labs.....	303
Electrad, Inc.....	304
General Cement Mfg. Co.....	313
General Electric Company.....	Back Cover
Goldenone Radio Company.....	311
The Goodheart-Willcox Co.....	310
Greepark Company.....	314
Hammarlund Mfg. Company.....	314
Hygrade-Sylvania Corp.....	299
Industrial Amplifier Systems Co.....	308
Insullne Corp. of America.....	316
Jobs & Careers.....	314
L & I. Electric Company.....	304
Lansing Mfg. Company.....	298
Lincoln Engineering School.....	316
McMurdo-Silver Corp.....	317
Messner Mfg. Company.....	315
Midwest Radio Corporation.....	Inside Front Cover
Milhon Radio & Tel. Labs.....	308
National Radio Institute.....	259
National Schools.....	312
National Union Radio Club.....	309
New York Y.M.C.A. Schools.....	304
Norwest Radio Labs.....	312
The Oxford-Tastak Radio Co.....	304
Paramount Trading Co.....	308
Peerless Sound Labs.....	313
Pavelain Products, Inc.....	302
Powertone Electric Corp.....	310
Precision Apparatus Corp.....	313
Precision Sound Labs.....	309
Radio & Technical Publ. Co.....	301
Radio & Television Institute.....	303
Radio Circular Company.....	298
Radio City Products Co.....	311
Radio Publications.....	318
Radio Service Institute.....	296
Radio Training Assoc. of America.....	305
Radtek Company.....	319
Raytheon Production Corp.....	307
R. A. Institutes, Inc.....	314
Readrite Meter Works.....	293
Remington Rand, Inc.....	306
S. O. S. Corporation.....	304
E. H. Scott Radio Lab.....	305
Shallerss Mfg. Company.....	317
Solar Mfg. Company.....	309
South Lond Lath Works.....	316
Sprayberry Academy of Radio.....	Insert
Superior Instrument Co.....	313
Supreme Instruments Corp.....	Insert
Supreme Sound Labs.....	314
Telex Company.....	304
The Plan Shop.....	306
The Radio Company.....	300
Thordars in Elec. Mfg. Co.....	306
Tel-L Mfg. Company.....	297
Trimm Radio Mfg. Co.....	306
Triplet Elec. Instrument Co.....	320
Triumph Mfg. Company.....	301
Try-Mo-Radio Co., Inc.....	310
Tung Sol Lamp Works, Inc.....	315
United Sound Engineering Co.....	301
Universal Microphone Co., Ltd.....	311
D. L. Van Leuten.....	304
Wedke Mfg. Company.....	302
Weldworth Trading Company.....	312
Weston Elec. Instrument Corp.....	262
Wholesale Radio Service Co.....	Inside Back Cover
Wright-DeCoster, Inc.....	319
Zephyr Radio Company.....	316

repeated for other coils. The coil which produces the greatest increase in meter reading at resonance has the highest Q.

Next month, calibration details and instructions for using the meter for many other purposes will be given.

- One Triplet Model 421 0-500 microammeter. M;
- One Hammarlund 20-500 mmf. *straight line capacity* condenser, type TC-500-C, C1;
- Two Aerovox mica condensers, 0.005 mf., type 1467, C2 and C4;
- One Aerovox dual-electrolytic condenser 8-16 mf. type P182, C3, C5;
- One Aerovox paper condenser, 0.1-mf., type 484, C6;
- One Anloy Transformer Co. special filament transformer, type 114-12, 6.3 V., T1;
- One Anloy Transformer Co. filter choke, type 730T, Ch.1;
- One Electrad 2-ohm filament ballast resistor, 30-W. type, R1;
- One Aerovox 1,000-ohm, 1/2-W. carbon resistor, type 1095, R2;
- One Aerovox 50,000 ohm, 1/2-W. carbon resistor, type 1095, R3;
- One Electrad wire-wound potentiometer, 200 ohms, R4;
- *One 70-ohm carbon resistor, 1/2-W., R5;
- One Aerovox 25,000-ohm carbon resistor, 1/2-W., type 1095, R6;
- One Aerovox 10,000-ohm carbon resistor, 1/2-W., type 1095, R7;
- *One 100-meg. carbon resistor, 1-W., R8;
- One 0.005-ohm resistor (see copy), R9;
- One I.C.A. S.P.S.T. snap switch, Sw.1;
- One Blan S.P. 3.T. snap switch, Sw.2;
- One Hammarlund, acorn-tube socket (for V1);
- One metal tube socket (for V2);
- One 4-prong socket (for V3);
- Seven I.C.A. insulated terminals, type 2305;
- One Amperite line-voltage control tube, type 3A5, V3;
- One RCA type 954 "acorn" pentode tube, V1;
- One Raytheon type 6X5G metal tube, V2;
- *One metal case, type 245;
- One Blan aluminum chassis, 9 x 4 1/2 x 1 1/2 ins.;
- One I.C.A. model 1156 pointer knob;
- One I.C.A. model 1155 pointer knob;
- **Photostat dial and escutcheon plates for panel.

*Names of manufacturers will be supplied upon receipt of a stamped and self-addressed envelope.
 **With reference to obtaining the dial and switch-escutcheons, as used in the original Q Adapter, information can be obtained by writing to the author in care of *Radio-Craft*.

PUTTING NEW TRICKS IN OLD SETS

(Continued from page 317)

the vibrator will refuse to "vib," or the 6Y3 tube will not light.

CHECK FROM A TO Z

Check all connections thoroughly before replacing the tubes and turning on the "juice." When you are satisfied—and only then—turn on the juice and check your voltages. The high "B" should be in the neighborhood of 225 V. at the screen-grid of the 42 tube, with a fully-charged battery. If it is not, and the new vibrator has not been necessary, proceed as follows. Turn the set over, remove the 42 tube, place the prod in the screen-grid hole of that tube and adjust the vibrator for *minimum buzz*, maximum voltage, and an amperage drain of approximately 7 A.

Check the candohm resistor on the front of the set. This resistor has 3 terminals, the center and extreme left-hand contacts are the 10,000-ohm resistor, and the extreme right-hand terminal is just a mounting terminal for the A.V.C. return leads (blue). Therefore, do not get excited if you do not get any reading from center to the extreme right, as there is nothing there. Incidentally this candohm resistor is a thoroughly bad actor. If there is any question about its resistance or if it shows "white corrosion," replace it with a 10-W. resistor of 10,000 ohms.

The next and final step is to replace the vibrator's covers and line-up the set on an *accurate oscillator, using an output meter*.

There are numerous other sets that can be treated in a like manner, and the writer will in future articles tell how to "re-vitalize" such sets as Philco sets No. 5, 6, 7, 11, Motorola Dual 6 and several others.

Specify NOKOIL

when ordering Permanent Magnet Speakers



Model 782 10" Re-producer \$7.82 list

The word NOKOIL was originated by us to introduce and tell the story of our efficient, small Permanent Magnet Speakers, first in the field and previously unknown to the trade. Now the word NOKOIL is being generally used to signify P.M. Speakers. Play safe, specify NOKOIL when ordering Permanent Magnet Speakers.

New Catalog showing improved units and lower prices now out. Write for copy and name of nearest distributor. Wright-DeCoster distributors are always anxious to cooperate.

WRIGHT-DECOSTER, Inc.

2251 University Ave., St. Paul, Minnesota
 Export Dept.—M. Simons & Son Co., New York.
 Cable Address: "Simontrice"
 Canadian Office, Associated Sales Co., Guelph, Ont.

NEW!
 The Radolek New 1937 Radio Profit Guide is the most complete Radio Parts Catalog ever published. Completely revised—right up to the minute, bringing you everything in Radio—and Public Address—at the right prices. Every page brings you extra profits! Contains over 10,000 individual Radio Repair Parts—hundreds of new items—a complete new selection of Radio Receivers, P. A. Amplifiers, Tools, Tubes, Books and Test Instruments. Everything you need—always in stock... ready for prompt shipment to you. You need this Big Radio Parts Catalog—**it's FREE!**
 Send for It!

RADOLEK

628 W. Randolph Street, Chicago, Illinois.

Name

Address

Service man? Dealer? Experimenter?

GIVE CONDENSERS A COMPLETE TEST HIGH VOLTAGE BREAKDOWN Now AVAILABLE

MODEL 1240
CONDENSER TESTER
\$24.83



TRIPLET

Test all radio condensers completely. Partial tests are likely to be misleading. Many radio sets that are intermittent players suffer from faulty condensers paralyzing on surges. Only a high voltage breakdown test will catch this trouble. Now available only in Triplet Model 1240. Test is made with a D.C. pulsating current simulating actual radio set operation.

For leakages the meter test prevents errors in counting flashes on the usual neon test; also eliminates waiting. The instrument pointer indicates infinitesimal leakages with certainty. Illuminated dial line voltage indicator with control provides for extreme accuracy in capacity readings. All tests are shown on a single Triplet precision instrument.

See Your Jobber — Write for More Information

THIS IS A TRIPLET MASTER UNIT!

ALL MASTER UNITS WILL FIT
THIS CARRYING CASE



- ★ CHECKS CAPACITIES ACCURATELY. ★ DETECTS SHORTS AND LEAKAGE.
- ★ DISCHARGES CONDENSER ON REMOVING PREVENTING SHOCKS.
- ★ CHECKS ALL TYPES RADIO CONDENSERS FROM .0001 TO 10 MFG.

OTHER TRIPLET MASTER UNITS

- **VOLT-OHM-MILLIAMMETER.** Model 1200-A. Low ohm scale reading 1/2-500 ohms with 15 ohms center scale reading. Reads D.C. 10-50-250-500-1000 volts at 2,000 ohms per volt. A.C. 10-50-250-500-1000 volts. 1-10-50-250 D.C. Milliamperes; 1500 Ohms; 1.5 and 3 Megohms. Dealer Price **\$21.67**
- **VACUUM TUBE VOLTMETER.** Model 1250. The ultimate in drain and self calibrating. Accuracy independent of changing tube values. Readings are all direct on a Triplet linear scale twin instrument. Dealer Price **\$33.34**
- **AUDIO OSCILLATOR.** Model 1260. Generates pure sine wave without distortion or harmonics. Laboratory accuracy. Wide frequency range. Signal strength and impedance matching is variable, permitting matching with low, medium or high impedance input of amplifier or P.A. systems. A.C. operated. Dealer Price **\$28.33**

- **TUBE TESTER.** Model 1210-A. Tests all types of tubes under R.M.A. standards for load conditions. Direct reading colored GOOD-BAD scale. Large instrument. Dealer Price **\$20.00**
- **A.C. SIGNAL GENERATOR.** Model 1232. Large 12" direct reading Ke. fundamentals. Perfect attenuation. 400 Cycle Audio note. Now with peaked calibrated coils. Accuracy 1% on all bands. Dealer Price **\$25.00**
- **FREE POINT TESTER.** Model 1220-A. Used with Volt-Ohm-Milliammeter for set testing. Makes all series and parallel instrument connections through five sockets with standard R.M.A. markings. Has plug and cord with all adapters. Dealer Price **\$10.00**

The Triplet Master Unit Series is a coordinated line of Test Equipment designed to give extreme portability with maximum accuracy and protection against obsolescence. Each unit is precision built throughout and installed in a black wrinkle finish metal case of one standard size. The Radio Serviceman standardizing on the Triplet Master Unit series is insuring the maximum return to himself per dollar invested in equipment.

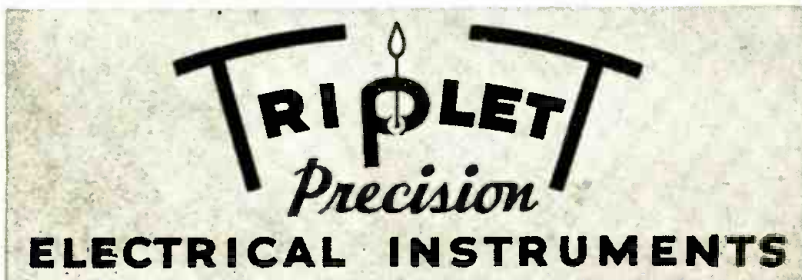

----- MAIL COUPON TODAY! -----

THE TRIPLET ELECTRICAL INSTRUMENT CO.
1611 Harmon Drive, Bluffton, Ohio

Without obligation please send me
.... more information on Model 1240 Condenser Tester
.... more information on the Triplet Master Unit Series

Name

St. Address

City State

Please Say That You Saw It in RADIO-CRAFT

THE BIG 1937

RADIO CATALOG

IT'S HERE
50,000 BUYS
GREATER THAN EVER



FREE!
Send the
Coupon

AMATEURS

A complete collection of "Ham" equipment is unfolded in the Blue Ribbon Radio Catalog. From the S. W. kit to the swiftest professional type receiver, Transmitters—parts—tubes—accessories—serials—hardware—all are here, in our big "ham" section—and at new "lows" in price.

SET-BUILDERS

When you "build your own"—be certain that you get parts which will give you the kind of reception you want. From over 50,000 items in this catalog you make your selection. Complete kits and parts for all circuits are described in detail.

EXPERIMENTERS

The vast experience of our technical personnel is at your service. Let us assist you in solving those knotty problems which crop up every so often—let us advise you on what parts to use. Save money, too.

SERVICEMEN

Shop at home with a Blue Ribbon Radio Catalog. Use your daylight hours for servicing—not shopping. The Blue Ribbon Radio Catalog can be your guide to greater profits. Lowest prices ever quoted on service instruments, parts, tubes, etc.

SOUNDMEN

Rely on WHOLESALE RADIO SERVICE CO., INC., to furnish you with the best in P. A. equipment—and at prices that give you plenty of room for decent profits. Our complete line described in the big P. A. section of the Blue Ribbon Radio Catalog.



THERE ISN'T A THING I CAN'T FIND AT WHOLESALE! FIND OUT FOR YOURSELF.

- THE world's greatest radio supply house scores again! In the 1937 "Blue Ribbon" Radio Catalog we give you the finest compilation of radio accessories you have ever seen. From hundreds of thousands of radio items available, our engineers have accepted only the best—after exhaustive tests in our own laboratories.
- HERE'S RADIO'S BIGGEST MONEY'S WORTH IN ONE GIGANTIC BOOK
Over 150 pages BIG—with more than 2,500 illustrations, and listing 50,000 items, this mastodonic catalog offers values never before obtainable. Only our tremendous purchasing power makes this possible.
- Our five completely stocked warehouses scattered throughout the country and our interlocking Teletype System assure you of TWENTY-FOUR-HOUR shipments. At new low WHOLESALE PRICES, you will find a brilliant array of new receivers listed in this catalog, all wave and short wave, from the smallest 4 tube A.C.-D.C. compact to the colossal 24 metal tube console fit for a king.
- Send for It Today—IT'S FREE

WHOLESALE RADIO SERVICE CO., Inc.
100 Sixth Avenue, New York, N. Y.

Rush FREE BLUE RIBBON CATALOG No. 3L.

NAME

ADDRESS

CITY STATE

WHOLESALE RADIO SERVICE CO. INC.

CHICAGO, ILL. • NEW YORK, N.Y. • ATLANTA, GA.
901 W. JACKSON BLVD. • 100 SIXTH AVENUE • 430 W. PEACHTREE ST., NW.

BRONX, N.Y. • NEWARK, N.J.
502 E. FORDHAM RD. • 219 CENTRAL AVE.

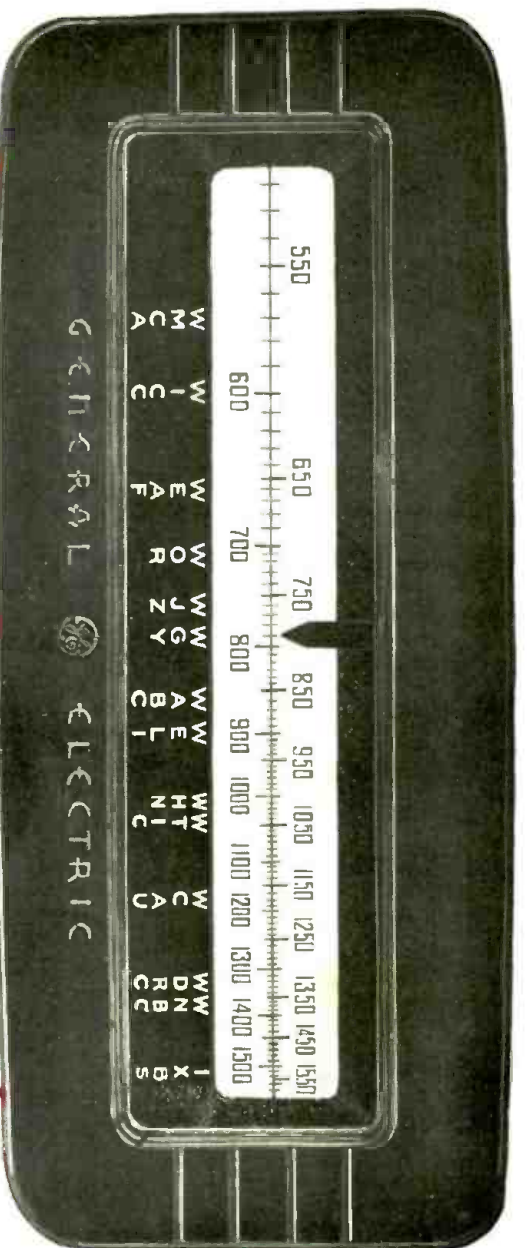

ONLY GENERAL ELECTRIC
Focused Tone Radio
DIAL has these 5 Sensational
FEATURES

These new and amazing features are but a few of the sensational radio improvements incorporated in the new 1937 General Electric Focused Tone Radio models. See —and hear—the new G-E Radio. The G-E radio dealer nearest you will gladly give you a demonstration.

FOR METAL TUBE RENEWALS, SPECIFY G-E METAL TUBES.

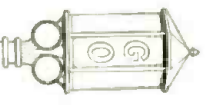

G-E COLORAMA TUNING
 The dial flashes automatically from red to green to guide you in the selection of stations. The red signal warns you reception is distorted or no station is tuned in. When the dial shows bright green, the signal is strong, and free from noise — every note is true and clear.



G-E LOCAL STATION PERSONALIZER
 The call letters of local stations flash on when you tune in. On the higher-priced models they are illuminated in green, individually. A "custom-made" scale is provided for each locality, listing the most popular stations in that area.

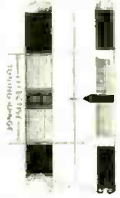

G-E AUTOMATIC FREQUENCY CONTROL
 As the dial pointer is moved into the approximate region of the station's resonance point on the dial scale, the receiver's tuned circuit automatically and instantly snaps into its perfect Focused Tone position. It's a dial you simply can't tune wrong.



G-E SILENT TUNING
 Absolutely silences the speaker as you tune across the dial, passing over strong stations to the one you are interested in at the moment. When the station desired is reached, simply push in the control knob and the program is heard at its maximum clarity.

G-E SLIDING-RULE TUNING SCALE



It is as easy to read as a ruler. All kilocycle positions are shown on a straight line — like the markings of a "slide-rule." On the majority of models, only one scale is visible at a time; when changing to another band,

a new scale is turned into position by the band-change switch. An automatic vernier reduction drive permits either rapid tuning or slow-speed tuning, without manual shifting of the tuning knob.

GENERAL ELECTRIC
Focused Tone Radio

APPLIANCE AND MERCHANDISE DEPT., GENERAL ELECTRIC CO., BRIDGEPORT, CONN.